

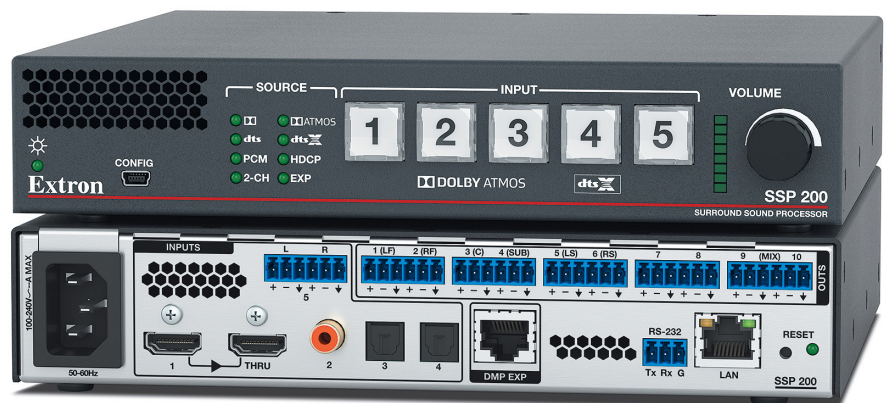

SSP 200

Surround Sound Processor



Safety Instructions

Safety Instructions • English

WARNING: This symbol, , when used on the product, is intended to alert the user of the presence of uninsulated dangerous voltage within the product's enclosure that may present a risk of electric shock.

ATTENTION: This symbol, , when used on the product, is intended to alert the user of important operating and maintenance (servicing) instructions in the literature provided with the equipment.

For information on safety guidelines, regulatory compliances, EMI/EMF compatibility, accessibility, and related topics, see the Extron Safety and Regulatory Compliance Guide, part number 68-290-01, on the Extron website, www.extron.com.

تعليمات السلامة • العربية

تحذير: هذا الرمز، , عند استخدامه على المنتج، مخصص لتنبيه المستخدم فيما يتعلق بوجود جهد كهربائي غير معزول على الغلاف الخارجي للمنتج وهو ما قد ينطوي على مخاطر حدوث صدمة كهربائية.

انتبه: هذا الرمز، , عند استخدامه على المنتج، مخصص لتنبيه المستخدم بتعليمات التشغيل والصيانة الهامة (الخدمة) في المواد التي يتم توفيرها مع المعدات.

للحصول على المزيد من المعلومات حول إرشادات السلامة، والتوافق التنظيمية، والتوافق الكهرومغناطيسي/المجال الكهرومغناطيسي، وإمكانية الوصول، والموضوعات ذات الصلة، يرجى مراجعة دليل السلامة والتوافق التنظيمي www.extron.com الخاص بإكسترون، الجزء رقم 01-290-68، على موقع إكسترون.

Sicherheitsanweisungen • Deutsch

WARUNG: Dieses Symbol , auf dem Produkt soll den Benutzer darauf aufmerksam machen, dass im Inneren des Gehäuses dieses Produktes gefährliche Spannungen herrschen, die nicht isoliert sind und die einen elektrischen Schlag verursachen können.

VORSICHT: Dieses Symbol , auf dem Produkt soll dem Benutzer in der im Lieferumfang enthaltenen Dokumentation besonders wichtige Hinweise zur Bedienung und Wartung (Instandhaltung) geben.

Weitere Informationen über die Sicherheitsrichtlinien, Produkthandhabung, EMI/EMF-Kompatibilität, Zugänglichkeit und verwandte Themen finden Sie in den Extron-Richtlinien für Sicherheit und Handhabung (Artikelnummer 68-290-01) auf der Extron-Website, www.extron.com.

Instrucciones de seguridad • Español

ADVERTENCIA: Este símbolo, , cuando se utiliza en el producto, avisa al usuario de la presencia de voltaje peligroso sin aislar dentro del producto, lo que puede representar un riesgo de descarga eléctrica.

ATENCIÓN: Este símbolo, , cuando se utiliza en el producto, avisa al usuario de la presencia de importantes instrucciones de uso y mantenimiento estas están incluidas en la documentación proporcionada con el equipo.

Para obtener información sobre directrices de seguridad, cumplimiento de normativas, compatibilidad electromagnética, accesibilidad y temas relacionados, consulte la Guía de cumplimiento de normativas y seguridad de Extron, referencia 68-290-01, en el sitio Web de Extron, www.extron.com.

Instructions de sécurité • Français

AVERTISSEMENT : Ce pictogramme, , lorsqu'il est utilisé sur le produit, signale à l'utilisateur la présence à l'intérieur du boîtier du produit d'une tension électrique dangereuse susceptible de provoquer un choc électrique.

ATTENTION : Ce pictogramme, , lorsqu'il est utilisé sur le produit, signale à l'utilisateur des instructions d'utilisation ou de maintenance importantes qui se trouvent dans la documentation fournie avec l'équipement.

Pour en savoir plus sur les règles de sécurité, la conformité à la réglementation, la compatibilité EMI/EMF, l'accessibilité, et autres sujets connexes, lisez les informations de sécurité et de conformité Extron, réf. 68-290-01, sur le site Extron, www.extron.com.

Istruzioni di sicurezza • Italiano

AVVERTENZA: Il simbolo, , se usato sul prodotto, serve ad avvertire l'utente della presenza di tensione non isolata pericolosa all'interno del contenitore del prodotto che può costituire un rischio di scosse elettriche.

ATTENZIONE: Il simbolo, , se usato sul prodotto, serve ad avvertire l'utente della presenza di importanti istruzioni di funzionamento e manutenzione nella documentazione fornita con l'apparecchio.

Per informazioni su parametri di sicurezza, conformità alle normative, compatibilità EMI/EMF, accessibilità e argomenti simili, fare riferimento alla Guida alla conformità normativa e di sicurezza di Extron, cod. articolo 68-290-01, sul sito web di Extron, www.extron.com.

Instrukcje bezpieczeństwa • Polska

OSTRZEŻENIE: Ten symbol, , gdy używany na produkt, ma na celu poinformować użytkownika o obecności izolowanego i niebezpiecznego napięcia wewnątrz obudowy produktu, który może stanowić zagrożenie porażenia prądem elektrycznym.

UWAGI: Ten symbol, , gdy używany na produkt, jest przeznaczony do ostrzeżenia użytkownika ważne operacyjne oraz instrukcje konserwacji (obsługi) w literaturze, wyposażone w sprzęt.

Informacji na temat wytycznych w sprawie bezpieczeństwa, regulacji wzajemnej zgodności, zgodność EMI/EMF, dostępności i Tematy pokrewne, zobacz Extron bezpieczeństwa i regulacyjnego zgodności przewodnik, część numer 68-290-01, na stronie internetowej Extron, www.extron.com.

Инструкция по технике безопасности • Русский

ПРЕДУПРЕЖДЕНИЕ: Данный символ, , если указан на продукте, предупреждает пользователя о наличии неизолированного опасного напряжения внутри корпуса продукта, которое может привести к поражению электрическим током.

ВНИМАНИЕ: Данный символ, , если указан на продукте, предупреждает пользователя о наличии важных инструкций по эксплуатации и обслуживанию в руководстве, прилагаемом к данному оборудованию.

Для получения информации о правилах техники безопасности, соблюдении нормативных требований, электромагнитной совместимости (ЭМП/ЭДС), возможности доступа и других вопросах см. руководство по безопасности и соблюдению нормативных требований Extron на сайте Extron: www.extron.com.

安全說明 (簡體中文) - 68-290-01.

警告: ⚠️ 產品上的這個標志意在警告用戶，該產品機殼內有暴露的危險電壓，有觸電危險。

注意: ⚠️ 產品上的這個標志意在提示用戶，設備隨附的用戶手冊中有重要的操作和維護(維修)說明。

關於我們產品的安全指南、遵循的規範、EMI/EMF 的兼容性、無障礙使用的特性等相關內容，敬請訪問 Extron 網站，www.extron.com，參見 Extron 安全規範指南，產品編號 68-290-01。

安全記事 • 繁體中文

警告: ⚠️ 若產品上使用此符號，是為了提醒使用者，產品機殼內存在未隔離的危險電壓，可能會導致觸電之風險。

注意: ⚠️ 若產品上使用此符號，是為了提醒使用者，設備隨附的用戶手冊中有重要的操作和維護(維修)說明。

有關安全性指導方針、法規遵守、EMI/EMF 相容性、存取範圍和相關主題的詳細資訊，請瀏覽 Extron 網站：www.extron.com，然後參閱《Extron 安全性與法規遵守手冊》，準則編號 68-290-01。

安全上のご注意 • 日本語

警告: この記号 ⚠️ が製品上に表示されている場合は、筐体内に絶縁されていない高電圧が流れ、感電の危険があることを示しています。

注意: この記号 ⚠️ が製品上に表示されている場合は、本機の取扱説明書に記載されている重要な操作と保守(整備)の指示についてユーザーの注意を喚起するものです。

安全上のご注意、法規遵守、EMI/EMF適合性、その他の関連項目については、エクストロンのウェブサイト www.extron.com より『Extron Safety and Regulatory Compliance Guide』(P/N 68-290-01)をご覧ください。

안전 지침 • 한국어

경고: 이 기호 ⚠️가 제품에 사용될 경우, 제품의 인클로저 내에 있는 접지되지 않은 위험한 전류로 인해 사용자가 감전될 위험이 있음을 경고합니다.

주의: 이 기호 ⚠️가 제품에 사용될 경우, 장비와 함께 제공된 책자에 나와 있는 주요 운영 및 유지보수(정비) 지침을 경고합니다.

안전 가이드라인, 규제 준수, EMI/EMF 호환성, 접근성, 그리고 관련 항목에 대한 자세한 내용은 Extron 웹 사이트(www.extron.com)의 Extron 안전 및 규제 준수 안내서, 68-290-01 조항을 참조하십시오.

Copyright

© 2021 Extron. All rights reserved.

Trademarks

All trademarks mentioned in this guide are the properties of their respective owners.

The following registered trademarks(®), registered service marks(™), and trademarks(™) are the property of RGB Systems, Inc. or Extron (see the current list of trademarks on the [Terms of Use](http://www.extron.com) page at www.extron.com):

Registered Trademarks (®)

Extron, Cable Cubby, ControlScript, CrossPoint, DTP, eBUS, EDID Manager, EDID Minder, Flat Field, FlexOS, Glitch Free, Global Configurator, Global Scriptor, GlobalViewer, Hideaway, HyperLane, IP Intercom, IP Link, Key Minder, LinkLicense, LockIt, MediaLink, MediaPort, NAV, NetPA, PlenumVault, PoleVault, PowerCage, PURE3, Quantum, Show Me, SoundField, SpeedMount, SpeedSwitch, StudioStation, System INTEGRATOR, TeamWork, TouchLink, V-Lock, VideoLounge, VN-Matrix, VoiceLift, WallVault, WindoWall, XPA, XTP, XTP Systems, and ZipClip

Registered Service Mark (™): S3 Service Support Solutions

Trademarks (™)

AAP, AFL (Accu-RATE Frame Lock), ADSP (Advanced Digital Sync Processing), CableCover, CDRS (Class D Ripple Suppression), Codec Connect, DDSP (Digital Display Sync Processing), DMI (Dynamic Motion Interpolation), Driver Configurator, DSP Configurator, DSVP (Digital Sync Validation Processing), eLink, EQIP, Everlast, FastBite, Flex55, FOX, FOXBOX, IP Intercom HelpDesk, MAA, MicroDigital, Opti-Torque, PendantConnect, ProDSP, QS-FPC (QuickSwitch Front Panel Controller), Room Agent, Scope-Trigger, ShareLink, SIS, Simple Instruction Set, Skew-Free, SpeedNav, Triple-Action Switching, True4K, Vector™ 4K, WebShare, XTRA, and ZipCaddy

FCC Class A Notice

This equipment has been tested and found to comply with the limits for a Class A digital device, pursuant to part 15 of the FCC rules. The Class A limits provide reasonable protection against harmful interference when the equipment is operated in a commercial environment. This equipment generates, uses, and can radiate radio frequency energy and, if not installed and used in accordance with the instruction manual, may cause harmful interference to radio communications. Operation of this equipment in a residential area is likely to cause interference. This interference must be corrected at the expense of the user.

ATTENTION:

- The Twisted Pair Extension technology works with unshielded twisted pair (UTP) or shielded twisted pair (STP) cables; **but to ensure FCC Class A and CE compliance, STP cables and STP Connectors are required.**
- La technologie extension paires torsadées fonctionne avec les câbles paires torsadées blindées (UTP) ou non blindées (STP). Afin de s'assurer de la compatibilité entre FCC Classe A et CE, les câbles STP et les connecteurs STP sont nécessaires.

NOTES:

- This unit was tested with shielded I/O cables on the peripheral devices. Shielded cables must be used to ensure compliance with FCC emissions limits.
- For more information on safety guidelines, regulatory compliances, EMI/EMF compatibility, accessibility, and related topics, see the [Extron Safety and Regulatory Compliance Guide](#) on the Extron website.

Battery Notice

This product contains a battery. **Do not open the unit to replace the battery.** If the battery needs replacing, return the entire unit to Extron (for the correct address, see the Extron Warranty section on the last page of this guide).

CAUTION: Risk of explosion. Do not replace the battery with an incorrect type. Dispose of used batteries according to the instructions.

ATTENTION : Risque d'explosion. Ne pas remplacer la pile par le mauvais type de pile. Débarrassez-vous des piles usagées selon le mode d'emploi.

Conventions Used in this Guide

Notifications

The following notifications are used in this guide:

 **WARNING:** Potential risk of severe injury or death.
AVERTISSEMENT : Risque potentiel de blessure grave ou de mort.

CAUTION: Risk of minor personal injury.
ATTENTION : Risque de blessure mineure.

ATTENTION:

- Risk of property damage.
- Risque de dommages matériels.

NOTE: A note draws attention to important information.

TIP: A tip provides a suggestion to make working with the application easier.

Software Commands

Commands are written in the fonts shown here:

```
^AR Merge Scene, ,Op1 scene 1,1 ^B 51 ^W^C  
[01] R000400300004000080000600 [02] 35 [17] [03]
```

```
Esc [X1] * [X17] * [X20] * [X23] * [X21] CE ←
```

NOTE: For commands and examples of computer or device responses mentioned in this guide, the character “0” is used for the number zero and “O” is the capital letter “o.”

Computer responses and directory paths that do not have variables are written in the font shown here:

```
Reply from 208.132.180.48: bytes=32 times=2ms TTL=32  
C:\Program Files\Extron
```

Variables are written in slanted form as shown here:

```
ping xxx.xxx.xxx.xxx -t  
SOH R Data STX Command ETB ETX
```

Selectable items, such as menu names, menu options, buttons, tabs, and field names are written in the font shown here:

```
From the File menu, select New.  
Click the OK button.
```

Specifications Availability

Product specifications are available on the Extron website, www.extron.com.

Extron Glossary of Terms

A glossary of terms is available at <http://www.extron.com/technology/glossary.aspx>.



Contents

Introduction 1

About the SSP 200.....	1
SSP 200 Features	2
Application Diagrams.....	3
Mounting	5
Tabletop Placement	5
Rack Mounting	5
Under-desk Mounting	5

Panel Features..... 6

Rear Panel Features	6
Securing an HDMI Connector	10
Front Panel Features.....	11
Source Format.....	11
Input Selection.....	12
Volume Adjustment.....	13
Analog Input Gain Level.....	13
System Reset	14
Front Panel Security Lockout (Executive Mode)	15
Connecting to the USB Port	16

Speaker Setup 18

Speaker Placement	18
Back Speakers	21
Bass Management	21
Speaker Settings	21
Speaker Delay Settings.....	22
Test Signals	22
Output Channel Trim Settings	23
Listening Mode Settings	23
Equalization	23

Reference 24

Source Formats.....	24
Dolby Digital Source Formats.....	25
DTS Source Formats (DTS).....	25
PCM Digital Source Format (PCM).....	26
2-Channel Source Format (2CH).....	26
Sampling Frequency	27
Listening Mode Options and Usage.....	27
Listening Mode Options.....	27

Product Configuration Software 29

Downloading PCS from the Extron Website	29
Using PCS Software.....	30
Connecting to the SSP 200	30
Main Menu	31
I/O Panel	32
Input/Output Config.....	32
EDID Minder	35
Audio Config.....	41
General Settings	50
Device Menu.....	57
Reset Device	57
PCS Help File	58
Updating Firmware Using PCS	58
Downloading the SSP 200 Firmware.....	58
Loading the Firmware to the SSP 200	59

SIS Configuration and Control 62

Connection Options.....	62
RS-232 Port	62
Front Panel Configuration Port.....	62
Ethernet (LAN) Port.....	63
Verbose Mode	64
Host-to-device Communications	64
Password Information	64
Error Responses.....	65
Using the Command and Response Tables	65
Symbol Definitions.....	65
Command and Response Tables.....	69

Internal Web Page 80

Overview of the Internal Web Page.....	80
Accessing the Internal Web Page	80
Web Page Components	81
Device Info.....	81
Device Status	82
Network Settings.....	83
Inputs	84
Outputs	84
RS-232.....	85
Roles and Permissions	85
Firmware	86

Introduction

This manual explains how to mount, install, and configure the Extron SSP 200 Surround Sound Processor.

Unless otherwise specified, references in this manual to the SSP 200, “SSP”, “surround sound processor”, or “processor” all refer to the SSP 200 device.

About the SSP 200

The SSP 200 is a high-performance digital audio surround sound processor in a half-rack, 1U form-factor. The SSP 200 automatically decodes Dolby® and DTS® formats from digital sources to discrete audio outputs.

The SSP 200 is compatible with all Extron (and non-Extron) products that accommodate analog balanced or unbalanced line level inputs. EXP expansion input connectivity allows the SSP 200 to integrate directly with EXP-enabled Extron products, such as the DMP Plus series and AXI 016 interface.

The SSP 200 can decode and process licensed, branded digital source formats from Dolby Digital and DTS, in their originally encoded formats. These include:

- Dolby Digital 2/0
- Dolby Digital 2/0 Surround
- Dolby Digital 5.1
- Dolby Digital Surround EX™
- Dolby Digital Plus
- Dolby Digital TrueHD
- Dolby Atmos
- DTS 2-channel
- DTS Digital Surround™
- DTS 96/24™
- DTS-ES® Matrix 6.1™
- DTS 96/24 ES Matrix 6.1
- DTS-ES Discrete 6.1™
- DTS-HD High Resolution Audio™
- DTS-HD Master Audio™

NOTES:

- Dolby, Dolby Atmos, and the double-D symbol are trademarks of Dolby Laboratories. Manufactured under license from Dolby Laboratories.
- For DTS patents, see <http://patents.dts.com>. Manufactured under license from DTS, Inc. DTS, the Symbol, DTS and the Symbol together, DTS:X, and the DTS:X logo are registered trademarks or trademarks of DTS, Inc. in the United States and/or other countries. © DTS, Inc. All Rights Reserved.

SSP 200 Features

- **Supports the latest immersive 3D audio formats as well as legacy surround formats:**
 - Dolby Atmos
 - Dolby TrueHD
 - Dolby Digital Plus
 - Dolby Surround
 - Dolby Digital EX
 - Dolby Digital
 - Dolby Pro Logic IIx
 - Dolby Pro Logic II
 - DTS:X
 - DTS-HD Master Audio
 - DTS-HD High Resolution Audio
 - DTS Neural:X
 - DTS-ES
 - DTS 96/24
 - DTS NEO:6
- **Automatic surround sound format detection and decoding** — Automatically detects the format of the incoming audio signal, applies the necessary decoding, and then sends signals to the appropriate outputs.
- **Supports video resolutions up to 4K/60 @ 4:4:4** — Supports video signal passed through unaltered.
- **Upmix listening mode converts source program into immersive or standard surround playback** — Converts from any input format to any selected higher output channel count format.
- **Integrated test signals for calibration and connectivity validation during set up.**
 - Pink noise generator to calibrate a speaker interaction within the environment.
 - Dolby Noise: bandpass noise generator to balance speaker levels.
 - External option: Can use test disc, or other calibration sources for specific decoding outputs.
- **EXP expansion output port** — Provides easy I/O connection to an Extron DMP Plus Series audio DSP processor. This allows for a higher output count and seamless integration with all DMP capabilities including Dante transport.
- **Lip Sync Offset** — 0 ms to 300 ms per input.
- **Supports commonly used speaker output configurations:**
 - 5.1, 7.1, and 5.1.2 with stereo downmix on outputs 9 and 10.
 - 5.1.4, 7.1.2, and 7.1.4 with stereo downmix on the EXP expansion bus.
 - EXP expansion bus connection to a DMP Plus Series processor is required for 7.1.4.
- **Supported HDMI 2.0b specification features include data rates up to 18 Gbps, HDR, Deep Color up to 12-bit, 3D, and HD lossless audio formats.**
- **HDMI Loop Output supports Downmix:**
 - Local monitor output audio modes.
 - Original Audio – Multichannel or two channel.
 - Stereo Downmix – Independent of speaker output configuration.
 - No Audio.

- **PCM input formats:**
 - Uncompressed stereo digital audio signals can be processed from the HDMI, TOSLINK, or Coaxial inputs.
 - Uncompressed 7.1 digital audio signals can be processed from the HDMI inputs.
- **Front panel input selection with LED indication.**
- **Supports 802.1X Authentication** — Provides support for IEEE 802.1X authentication standard for port-based Network Access Control.

Application Diagrams

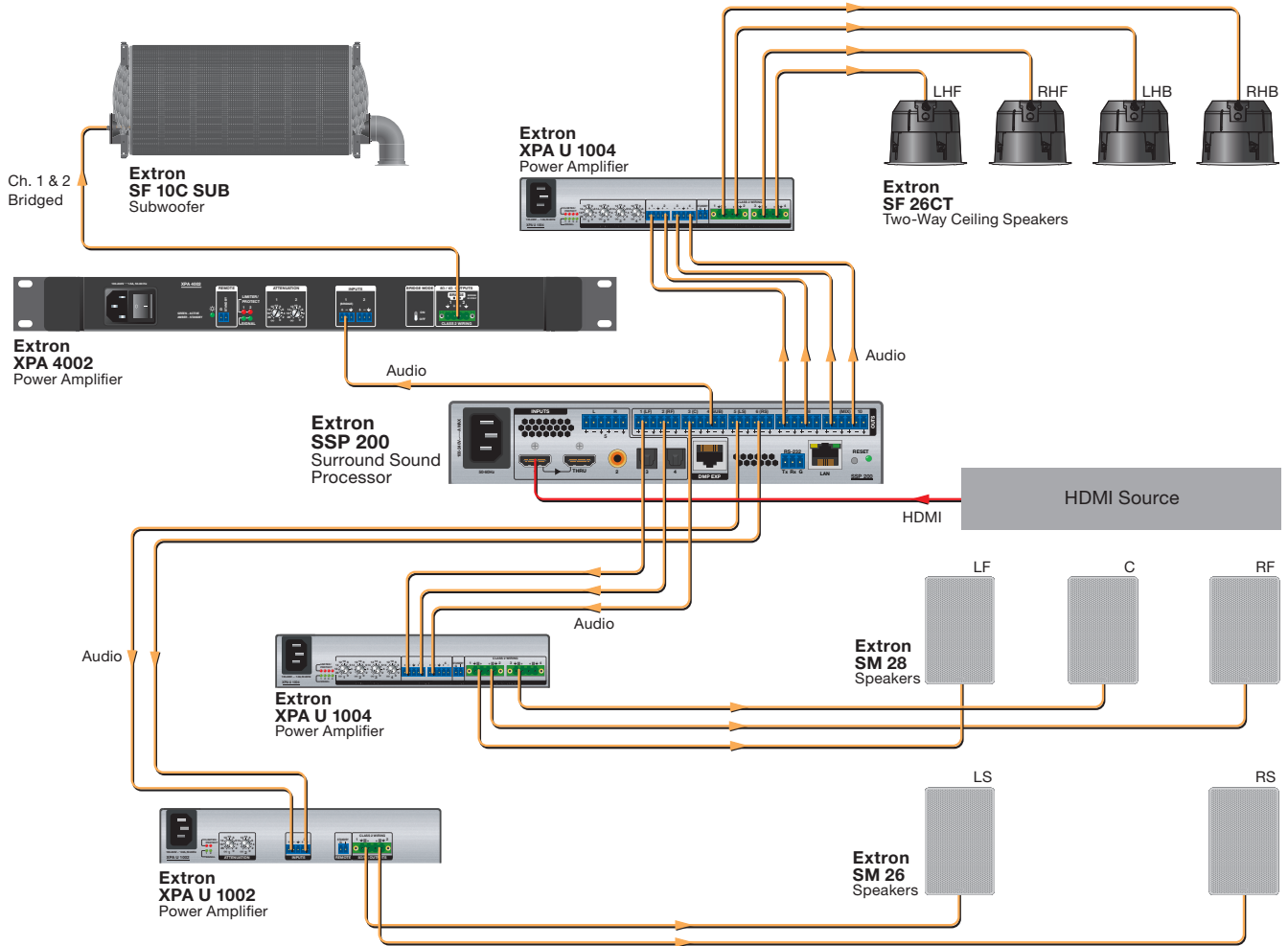

Figure 1. Typical Application with 5.1.4 Speaker Setup

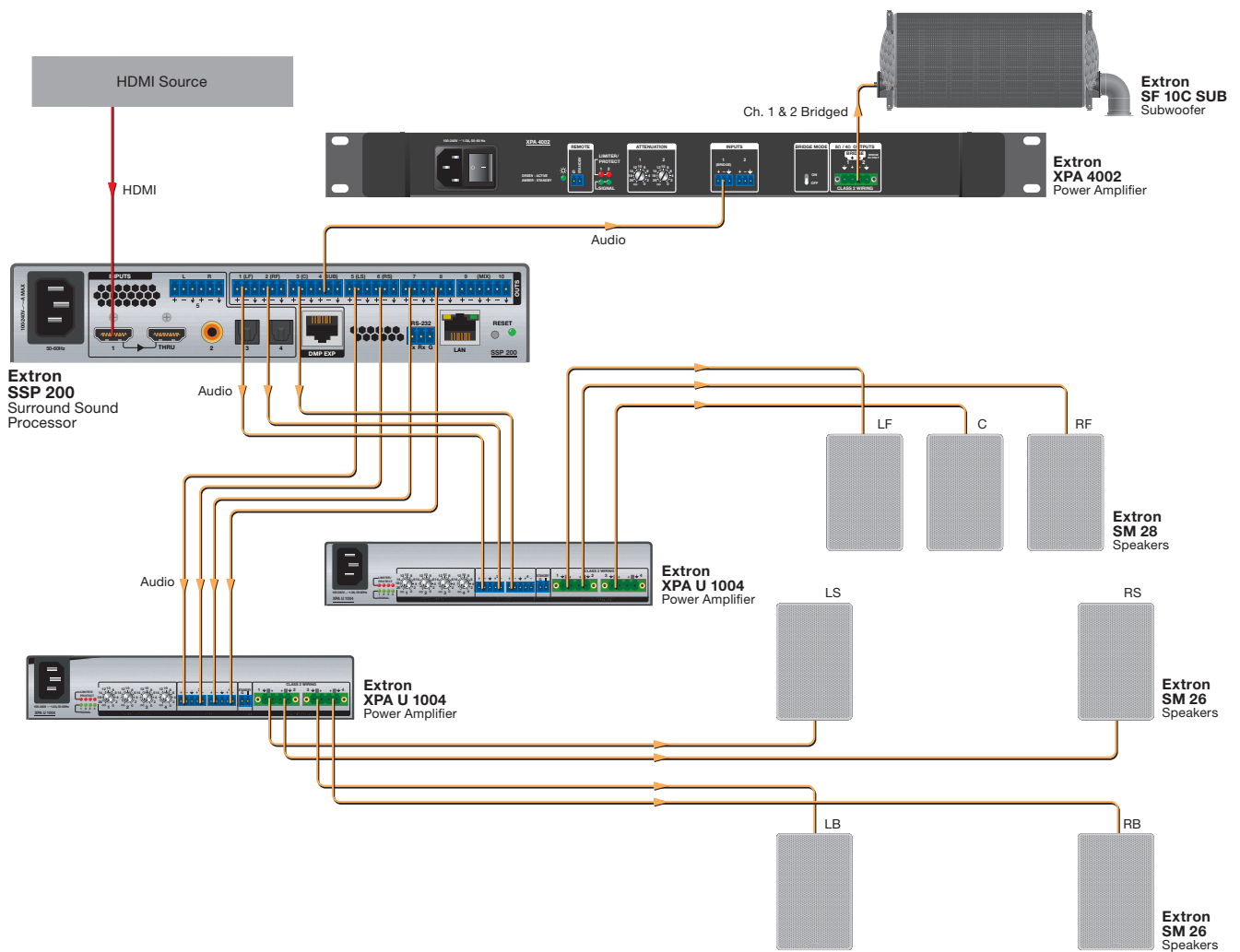

Figure 2. Typical Application with 7.1 Speaker Setup

Mounting

The SSP 200 can be set on a table, mounted on a rack shelf, or mounted under a desk, podium, or table.

ATTENTION:

- Installation and service must be performed by authorized personnel only.
- L'installation et l'entretien doivent être effectués uniquement par un technicien qualifié.

Tabletop Placement

Attach the four provided rubber feet to the bottom of the unit and place it in any convenient location.

Rack Mounting

See the Extron [website](#) for a list of optional rack mounting kits that are suitable for the SSP 200. Follow the instructions provided with the kit.

UL Guidelines for Rack Mounting

The following Underwriters Laboratories (UL) guidelines are relevant to the safe installation of these products in a rack:

- 1. Elevated operating ambient temperature** — If the unit is installed in a closed or multi-unit rack assembly, the operating ambient temperature of the rack environment may be greater than room ambient temperature. Therefore, install the equipment in an environment compatible with the maximum ambient temperature (T_{ma}: +122° F, +50° C) specified by Extron.
- 2. Reduced air flow** — Install the equipment in the rack so that the equipment gets adequate air flow for safe operation.
- 3. Mechanical loading** — Mount the equipment in the rack so that uneven mechanical loading does not create a hazardous condition.
- 4. Circuit overloading** — Connect the equipment to the supply circuit and consider the effect that circuit overloading might have on overcurrent protection and supply wiring. Appropriate consideration of the equipment nameplate ratings should be used when addressing this concern.
- 5. Reliable earthing (grounding)** — Maintain reliable grounding of rack-mounted equipment. Pay particular attention to supply connections other than direct connections to the branch circuit (such as the use of power strips).

Under-desk Mounting

See the Extron [website](#) to find the optional under-desk mounting kit that is suitable for the SSP 200. Follow the instructions provided with the kit.

Panel Features

This section describes:

- [Rear Panel Features](#)
- [Front Panel Features](#)

Rear Panel Features

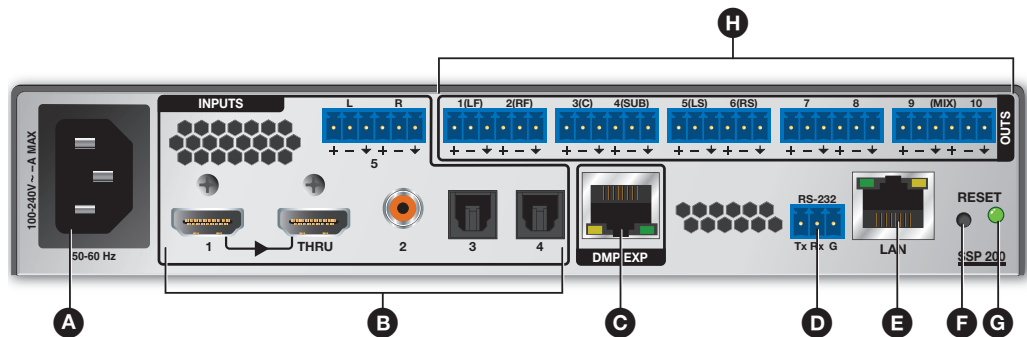

Figure 3. SSP 200 Rear Panel Features

- | | |
|-----------------------------|-------------------------|
| A AC power input | E LAN port |
| B Audio inputs | F Reset button |
| C DMP expansion port | G Status LED |
| D RS-232 port | H Analog outputs |

- A AC power input** — Use an IEC power cable to connect the processor to a 100 - 240 VAC, 50 - 60 Hz, power source.
- B Audio inputs** — The SSP 200 accepts four digital inputs and one analog input (see figure 4).

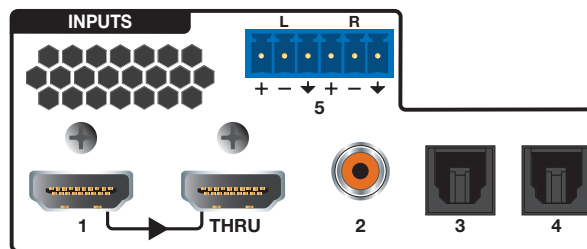

Figure 4. SSP 200 Audio Inputs

- Input 1 accepts digital signals through an HDMI cable (see [Securing an HDMI Connector](#) on page 10). The THRU connection passes the original HDMI video signal out, unaltered, to another device. Audio passed to the THRU connection is configurable (see [Input/Output Config](#) on page 32).
- Input 2 accepts digital signals through a S/PDIF coaxial cable.
- Inputs 3 and 4 accept digital signals through S/PDIF optical (TOSLINK) cables.

- Input 5 accepts a balanced or unbalanced, stereo or mono, analog input through a 6-pole captive screw connector. Figure 5 shows the correct wiring for different analog input signals using either 3-pole or 6-pole connectors.

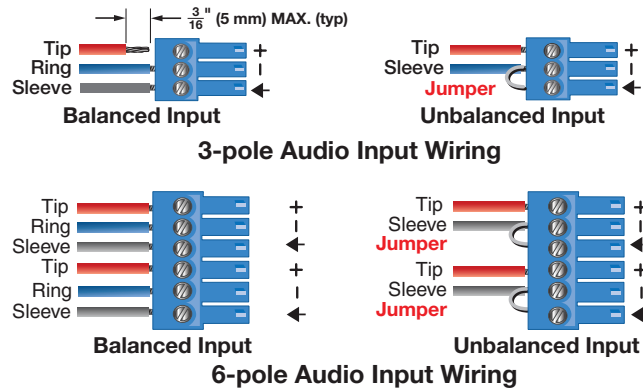

Figure 5. Analog Input (Input 5) Wiring

ATTENTION:

- Do not tin the wire leads before installing into the connector. Tinned wires are not as secure in the connector and could be pulled out.
- Ne pas étamer les conducteurs avant de les insérer dans le connecteur. Les câbles étamés ne sont pas aussi bien fixés dans le connecteur et pourraient être tirés.
- The length of the exposed wires in the stripping process is important. **The ideal length is 3/16 inches (5 mm).** Any longer and the exposed wires may touch, causing a short circuit between them. Any shorter and the wires can be easily pulled out even if tightly fastened by the captive screws.
- La longueur des câbles exposés est importante lorsque l'on entreprend de les dénuder. **La longueur idéale est de 5 mm (3/16 inches).** S'ils sont trop longs, les câbles exposés pourraient se toucher et provoquer un court-circuit. S'ils sont trop courts, ils peuvent être tirés facilement, même s'ils sont correctement serrés par les borniers à vis.

- C DMP Expansion port** — This proprietary Extron DMP Expansion port provides 14 output channels and 2 input channels (for use as a stereo input) for exclusive use with EXP-compatible Extron devices. The first 10 EXP output channels are duplicates of the 10 analog outputs (except for Downmix Left and Right, which always appear on EXP outputs 15 and 16). Two additional EXP Outputs are available for 7.1.4 speaker configurations.

The EXP port is limited to a sample rate of 48 kHz at 24-bit depth per channel. High sample rate codecs (such as DTS 96/24 at 96 kHz and Dolby TrueHD at a maximum 192 kHz) are first resampled to 48 kHz before transport via the EXP bus.

- D RS-232 port** — The SSP 200 can be configured with Extron Product Configuration Software (PCS) or Simple Instruction Set (SIS) commands using this 3-pole captive screw connector (see [Product Configuration Software](#) starting on page 29 and [SIS Configuration and Control](#) starting on page 62)

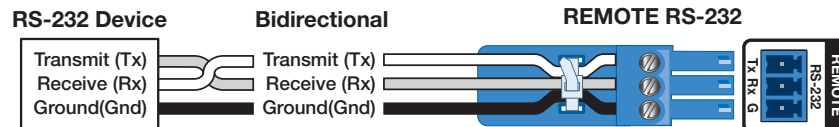

Figure 6. RS-232 Wiring Example

- E LAN port** — RJ-45 connector allows the SSP 200 to be connected to a Local Area Network (LAN) connection for control and configuration. As with the RS-232 and USB connections, the device can be controlled using SIS commands through an external control system or via PCS in order to configure the device and receive status information as required.

The Ethernet cable can be terminated as a straight-through cable or a crossover cable and must be properly terminated for your application (see figure 7 for wiring information).

- **Crossover cable** — Direct connection between the computer and the SSP 200.
- **Patch (straight) cable** — Connection of the SSP 200 to an Ethernet LAN.

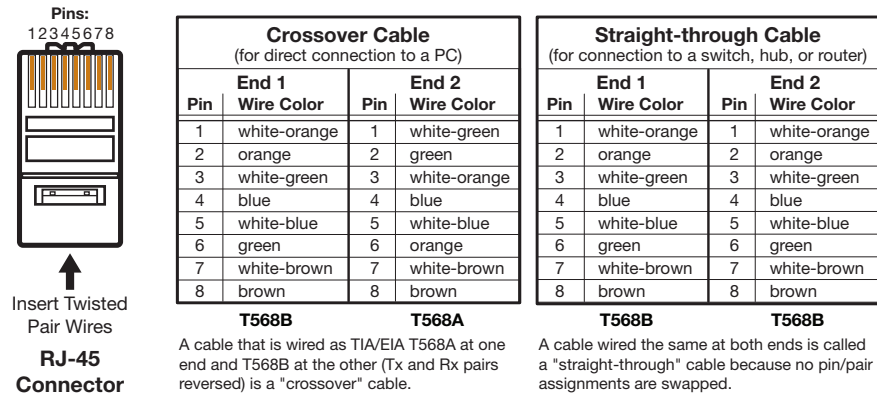

Figure 7. RJ-45 Ethernet Connector Pin Assignment

- F Reset button** — The Reset button initiates various levels of soft resets, which restore various tiers of SSP 200 settings to their defaults (see [System Reset](#) on page 14). Use a pointed stylus or small screwdriver (such as an Extron Tweaker) to press the internal button.
- G Status LED** — The Status LED is used in conjunction with the Reset button (see [System Reset](#) on page 14).
- H Analog outputs** (see figure 8) — Outputs are balanced or unbalanced line level analog signals that feed into multichannel amplifiers for configurations up to 7.1.2 or 5.1.4 surround sound. For more information, see [Speaker Placement](#) on page 18.

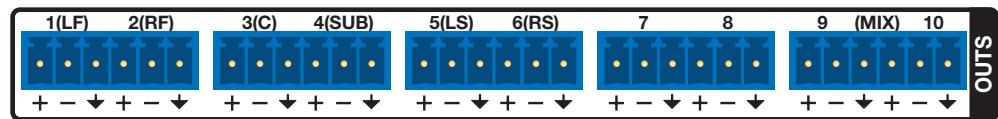

Figure 8. Analog Audio Outputs

Individual output settings are configured through PCS (see [Speaker Placement](#)) or SIS commands ([Layouts and Speakers](#) on page 78). Refer to the following table for output designations.

Numbers	Abbreviations	Channel Description
1	LF	Left Front
2	RF	Right Front
3	C	Center
4	SUB	Subwoofer (Mono)
5	LS	Left Surround
6	RS	Right Surround
7	<i>see note below</i>	
8	<i>see note below</i>	
9	<i>see note below</i>	
10	<i>see note below</i>	

NOTES:

- Numbers 7 through 10 are configurable as Back, Height, or Downmix using PCS.
- The **default configuration** is 7.1 with Downmix on numbers 9 and 10 enabled.

For information about speaker configuration and output formats, see [Listening Mode Options and Usage](#) on page 27. See figure 9 for audio output connector wiring.

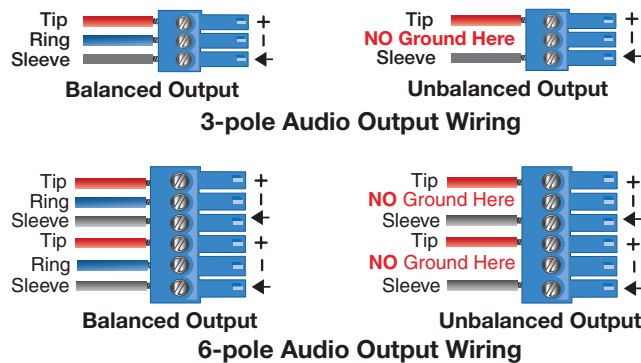

Figure 9. Audio Output Wiring

ATTENTION:

- For unbalanced audio, connect the sleeves to the ground contact. DO NOT connect the sleeves to the negative (-) contacts.
- Pour l'audio asymétrique, connectez les manchons au contact au sol. Ne PAS connecter les manchons aux contacts négatifs (-).

Securing an HDMI Connector

Follow these instructions to secure the HDMI connectors to the processor with the LockIt HDMI lacing bracket provided:

- 1 Plug the HDMI cable into the processor rear panel connection.
- 2 Loosen the HDMI connection mounting screw from the panel enough to allow the LockIt lacing bracket to be placed over it. The screw does not have to be removed.
- 3 Place the LockIt lacing bracket on the screw and against the HDMI connector, then tighten the screw to secure the bracket.

ATTENTION:

- Do not overtighten the HDMI connector mounting screw. The shield it fastens to is very thin and can easily be stripped.
- Ne serrez pas trop la vis de montage du connecteur HDMI. Le blindage auquel elle est attachée est très fin et peut facilement être dénudé.

- 4 Loosely place the included tie wrap around the HDMI connector and the LockIt lacing bracket as shown.
- 5 While holding the connector securely against the lacing bracket, tighten the tie wrap, then remove any excess length.

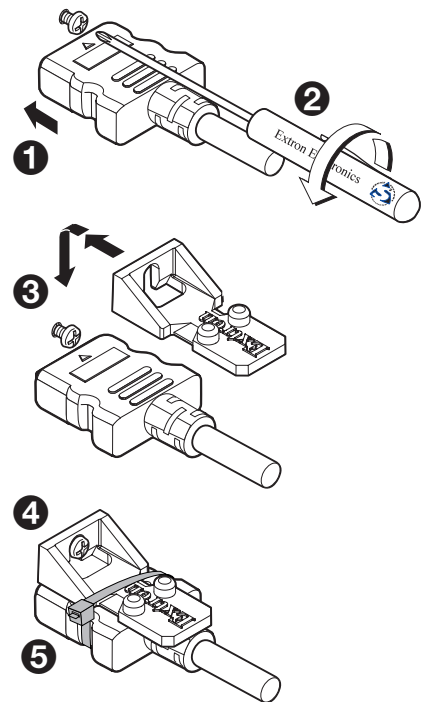

Front Panel Features

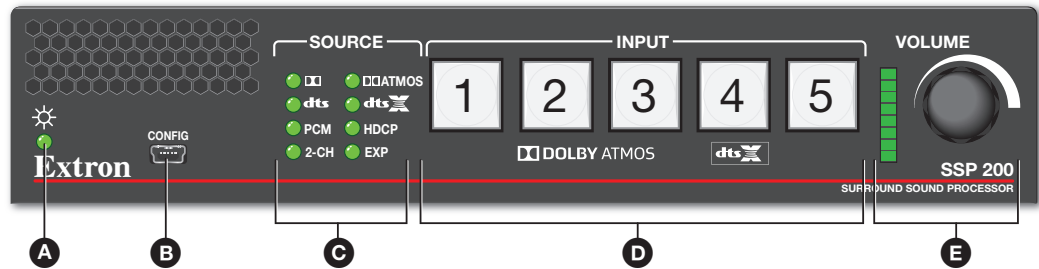

Figure 10. SSP 200 Front Panel Features

- A** Status LED
- B** Configuration port
- C** Input Source format indicators
- D** Input Selections
- E** Volume Adjustment

- A** **Status LED** — This LED indicates the current power and boot status of the SSP 200.
- B** **Configuration port** — The SSP 200 can be configured via PCS or by using Extron Simple Instruction Set (SIS) commands via this USB mini-B port or via the LAN and RS-232 ports on the rear panel (see [SIS Configuration and Control](#) starting on page 62). In addition, this configuration port is used for firmware updates from a PC.

NOTE: The front panel configuration port, the rear panel RS-232 port, and the rear panel LAN port can all be used at the same time. No connection has precedence. The SSP 200 responds to commands in the order received.

Source Format

- C** **Input Source format indicators** — The bank of eight LEDs identify the format of the audio input (see [Source Formats](#) starting on page 24).
 - **Dolby:** Dolby source material
 - **DTS:** DTS source material
 - **PCM:** 2-channel uncompressed digital source format up to 7.1 multi-channel

NOTES:

- A digital signal that does not have a supported sampling rate or is compressed PCM is considered an unrecognized signal and is muted.
- When a media player is paused during playback, the SSP 200 may or may not continue to receive source format information from the player. Some players continue to send the same source format information in a loop, allowing the SSP 200 to retain the previous settings. Other players completely disconnect the signal from the SSP 200 (unlocked state) so that the active input appears as if there is no connection present. The remainder of players change the source output to PCM without an actual signal being sent (digital silence). During digital silence, the PCM LED lights but the 2-CH source LED does not.

- **2-Channel (2-CH):**
 - Any source coming through analog input 5.
 - If a 2-Channel PCM digital signal is present on any of the digital inputs, both the PCM and the 2-CH LEDs light.
 - If a Dolby Digital 2/0 or Dolby Digital 2/0 Surround source is present, both the **DD** and the 2-CH LEDs light.
 - If a DTS 2-Channel source format is present, both the DTS and 2-CH LEDs light.
- **ATMOS:** Dolby Atmos source material
- **DTS:X:** DTS:X source material (HDMI only)
- **HDCP:** HDMI source material (HDMI only)
- **EXP:** Valid EXP connection. Blinks when the assigned EXP input is selected.

Input Selection

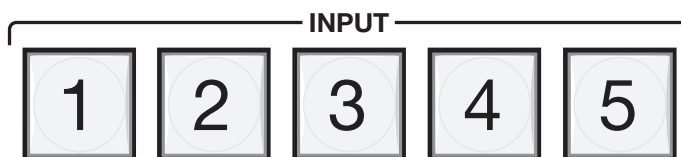

Figure 11. SSP 200 Input Selection Switches

D Input selection buttons — Push one of the buttons to select between the five audio inputs. When a button is selected, the button lights green indicating it is the active input. For digital inputs 1 through 4, the button turns amber when it is selected and the digital clock signal has **not** been detected.

The Input 5 button turns red when the analog input is clipping. The **Analog Input Gain Level** can be adjusted with the volume adjustment knob (see page 13).

The SSP accepts four digital inputs and one analog input (see **Rear Panel Features** on page 6):

- Input 1 accepts digital signals through an HDMI cable.
- Input 2 accepts digital signals through a S/PDIF coaxial cable.
- Inputs 3 and 4 accept digital signals through S/PDIF optical cables. The SSP 200 supports TOSLINK or TOSLINK-compatible optical connectors that conform to IEC-958, S/PDIF standards.

All four digital inputs accept 16- to 24-bit PCM audio at 32 kHz, 44.1 kHz, 48 kHz, 88.2 kHz, 96 kHz, and 192 kHz sample rates. They support Dolby Digital and DTS source formats.

- Input 5 accepts a balanced or unbalanced analog input through a 6-pin captive screw connector. The unit can be configured to accept:
 - A stereo signal
 - A mono signal (see **Listening Mode Options** on page 27)

The input can also be selected using PCS (see **Product Configuration Software** on page 29) and SIS commands (see **SIS Configuration and Control** on page 62).

Volume Adjustment

- E Volume control and LED bar** — Use the rotary encoder to adjust the output volume from 0% to 100%. The default setting is 80%.

As the volume increases or decreases, the LED bar lights to indicate the current volume setting (see the table below). As the volume is increased or decreased, the top LED flashes.

If the audio is muted using PCS or SIS, the entire LED bar blinks to indicate a muted state. The LEDs return to their previous state when the audio is unmuted.

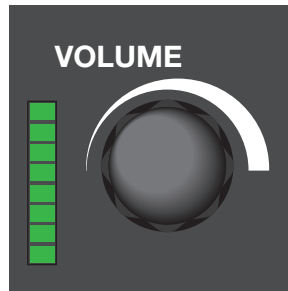

Figure 12. Volume Control and LED Bar

Volume steps for each LED	LEDs lit
96% to 100%	All 8 LEDs on
91% to 95%	Bottom 7 LEDs on
86% to 90%	Bottom 6 LEDs on
81% to 85%	Bottom 5 LEDs on
71% to 80%	Bottom 4 LEDs on
51% to 70%	Bottom 3 LEDs on
31% to 50%	Bottom 2 LEDs on
1% to 30%	Bottom LED on
0%	All LEDs flashing

The volume can also be controlled using SIS (see [Volume](#) on page 77).

Analog Input Gain Level

Alternatively, the rotary encoder controls the gain level of the analog signal on Input 5. Analog input gain is adjustable from -18 dB to +24 dB.

To adjust input gain, press and hold the Input 5 button, then turn the rotary encoder to increase or decrease the gain level of the input signal (see [figure 13](#) on the next page).

When the Input 5 button is released, the input gain level control is deactivated. All active (input level) LEDs in the LED array bar deactivate momentarily, and then re-activate to display the current volume setting.

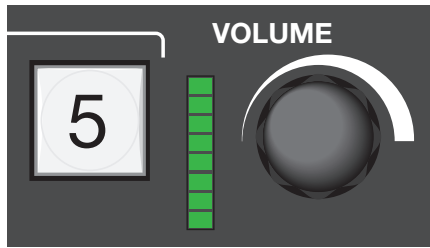

Figure 13. Analog Gain Control

NOTES:

- If the gain level is too high, clipping may occur. When clipping occurs, the Input 5 button lights red.
- When using **Mono** or **Mono to All** listening mode, the left and right signals are summed (in the digital domain), which can cause a boost in level up to 6 dB. This type of clipping does not cause the clip indicator LED to light but is audible. If using a mono mode, it is recommended that the input gain be reduced by 9 dB to prevent clipping from occurring.

While the Input 5 button is held down, the LED bar lights from the bottom up to indicate the current gain level (see table below).

Gain steps for each LED	LEDs lit
19 dB to 24 dB	All 8 LEDs on
13 dB to 18 dB	Bottom 7 LEDs on
7 dB to 12 dB	Bottom 6 LEDs on
1 dB to 6 dB	Bottom 5 LEDs on
-5 dB to 0 dB	Bottom 4 LEDs on
-11 dB to -6 dB	Bottom 3 LEDs on
-17 dB to -12 dB	Bottom 2 LEDs on
-18 dB	Bottom LED on

System Reset

The rear panel has a recessed Reset button that initiates various levels of soft resets restoring various tiers of SSP 200 settings to their defaults. For different reset levels, press and hold the button while the SSP 200 is running. Use a pointed stylus or small screwdriver (such as an Extron Tweaker) to press the button.

The following **Reset Modes Summary** table provides a list of the available reset modes, how to activate them, and the result of that activation.

NOTES:

- The reset modes listed on the next page close all open IP and Telnet connections, as well as close all sockets.
- The factory configured passwords for all accounts on this device have been set to the device serial number. Passwords are case sensitive. If the SSP 200 is reset, the passwords revert to the default, which is **extron**. A new password would need to be configured to secure the device.

Reset Modes Summary		
Mode	Activation	Result
1	Hold in the recessed Reset button while applying power to the device.	<ul style="list-style-type: none"> Restores the factory-installed firmware. Maintains all user settings (audio adjustments, IP settings, and so on).
4	Hold in the Reset button until the Reset LED blinks twice (once after approximately 3 seconds and again after 6 seconds). Then, within 1 second press Reset momentarily (for less than 1 second).	<ul style="list-style-type: none"> Sets the IP address, subnet address, and gateway address to the factory defaults. Sets port mapping to the factory default. Turns DHCP off. Turn event scripts off. <p>The Reset LED blinks four times in quick succession during the reset.</p>
5	Hold in the Reset button until the Reset LED blinks three times (once after approximately 3 seconds, again after 6 seconds, and then again after 9 seconds); then within 1 second press Reset momentarily (for less than 1 second).	<p>Performs a complete reset to factory defaults. The password reverts to extron.</p> <p>The Reset LED blinks four times in quick succession during the reset.</p>

Full system resets can also be performed using SIS commands (see [Resets](#) on page 78).

Front Panel Security Lockout (Executive Mode)

When the front panel is locked, the user cannot make any input changes from the front panel. If the user attempts to make changes with the front panel locked out, all the input button LEDs flash simultaneously. The lockout does not block changes made using SIS commands or PCS. There are three lockout modes available:

- Mode 1 — All front panel controls are locked. No adjustments can be made.
- Mode 2 — All front panel controls are locked except for volume control. This allows the volume to be adjusted, without the ability to change inputs.
- Mode 3 — All front controls are locked, except for input selection buttons.

This feature can only be set using SIS commands (see [SIS Configuration and Control](#) on page 62) or PCS (see [Front Panel Lockout \(Executive Mode\)](#) on page 52).

Connecting to the USB Port

Use the USB mini-B port on the front panel to connect the processor to a host computer to configure the unit with PCS or SIS commands.

1. Connect a USB A to mini-B cable between the front panel USB CONFIG port and a USB port on the PC (see figure 14).

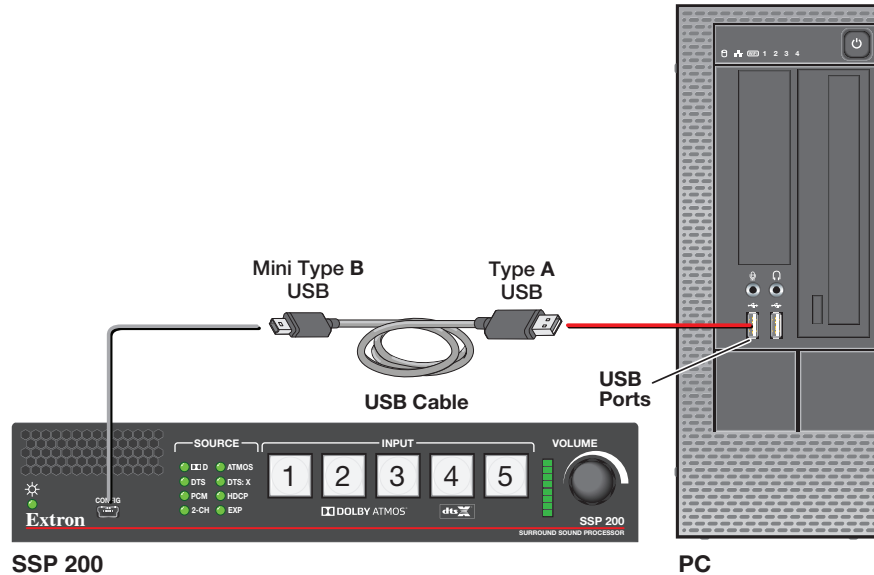

Figure 14. Connecting a PC to the SSP 200 Front Panel USB Port

If this is the first time the SSP 200 has been connected to the PC, the Found New Hardware Wizard opens (see figure 15).

The first screen offers to connect to Windows Update to search the web for the appropriate driver needed for the USB port to communicate with the SSP 200. This is not necessary if the USB driver is already on your PC.

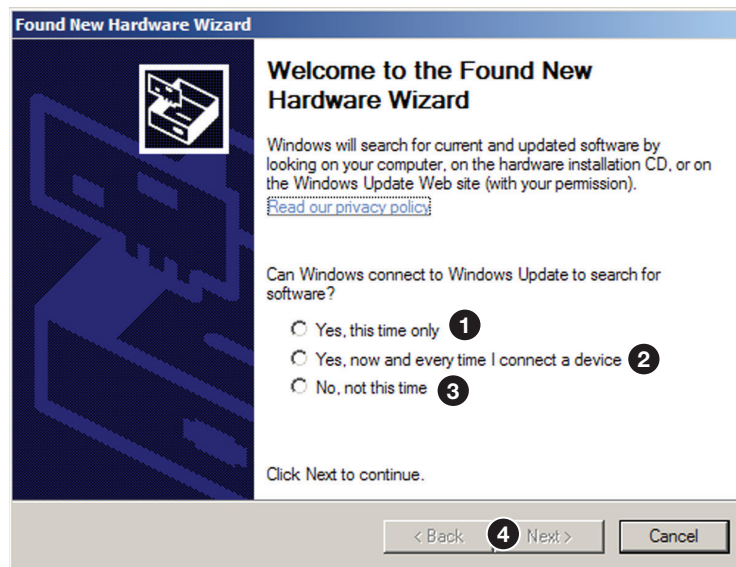

Figure 15. Found New Hardware Wizard Opening Screen

2. Click on the appropriate radio button (see figure 15).
 - Select the **Yes, this time only** radio button (1) if you want your computer to connect to Windows Update only this one time.

- Select **Yes, now and every time I connect a device** (see [figure 15, ②](#), on the previous page) if you want the computer to automatically connect to **Windows Update** to search the web every time the processor is connected to this USB port.
 - Select **No, not this time** (③) if you do not want the computer to connect to **Windows Update** to search the web at this time (for example, if the driver is already on your computer).
3. Click **Next** (④).

The next screen of the Wizard opens:

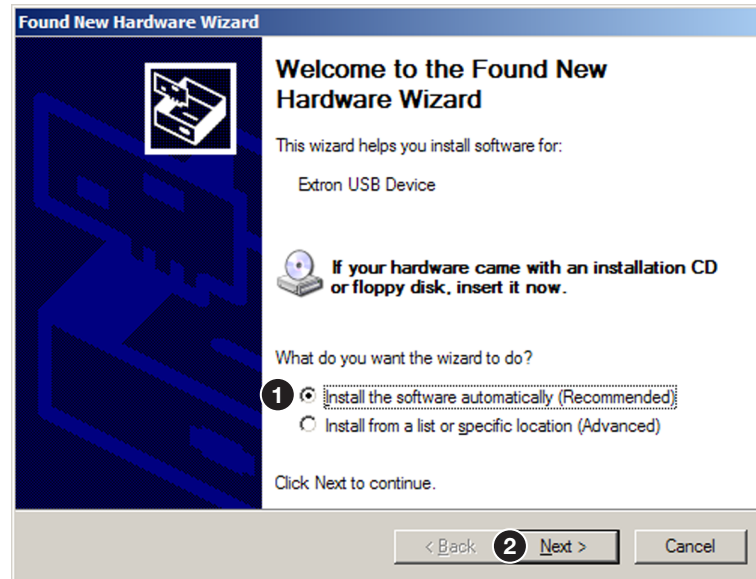

Figure 16. Installing the Software Automatically

4. Select the **Install the software automatically (Recommended)** radio button (see figure 16, ①).
5. Click **Next** (②).

NOTE: You do not need to insert a disc.

The PC locates the driver needed and installs it in the correct location on the hard drive.

6. When the **Completed** screen appears, click **Finish** to close the wizard.

NOTE: The wizard opens only on the first occasion you connect the SSP 200 to that USB port. The wizard reappears if you connect the unit to a different USB port or if you connect a different piece of equipment, requiring a different driver, to the same USB port.

7. Configure the processor as desired using SIS commands (see [SIS Configuration and Control](#) starting on page 62) or PCS (see [Using PCS Software](#) starting on page 30).

Speaker Setup

This section provides background information about arranging speakers in a room and the settings that can be adjusted by the Product Configuration Software (PCS). Extron recommends that the PCS is used to make configuration changes to the SSP 200 (see [Product Configuration Software](#) starting on page 29). Topics in this section include:

- [Speaker Placement](#)
- [Back Speakers](#)
- [Bass Management](#)
- [Speaker Delay Settings](#)
- [Test Signals](#)
- [Output Channel Trim Settings](#)
- [Listening Mode Settings](#)
- [Equalization](#)

Speaker Placement

The following figures show the recommended speaker placement, relative to the listener, for some of the most common speaker configurations.

Speaker Abbreviations

Abbreviations	Channel Description	Abbreviations	Channel Description
LF	Left Front	RB	Right Back
RF	Right Front	LH	Left Height
C	Center	RH	Right Height
SUB	Subwoofer (Mono)	LHF	Left Height Front
LS	Left Surround	RHF	Right Height Front
RS	Right Surround	LHB	Left Height Back
LB	Left Back	RHB	Right Height Back

NOTE: All speakers should be angled inwards so that they face towards the listener.

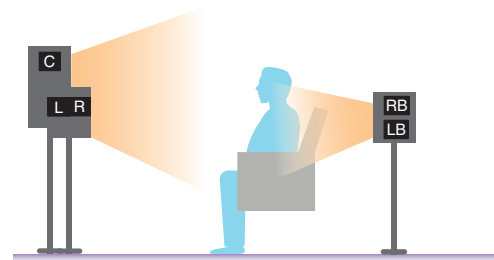
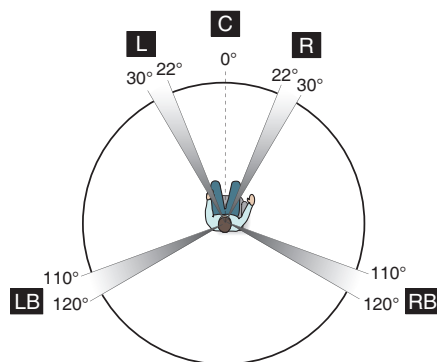

Figure 17. Speaker 5.1 Setup

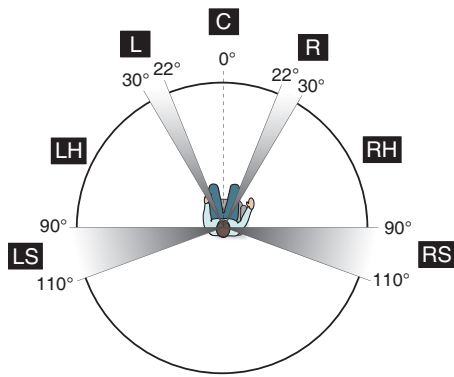

Figure 18. Speaker 5.1.2 Setup

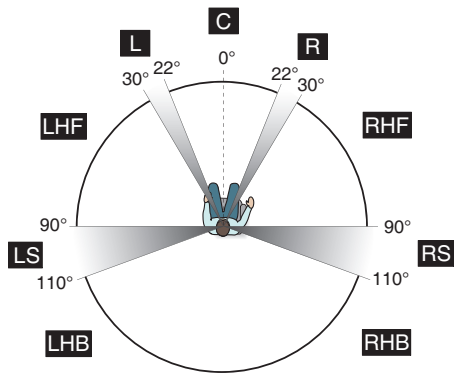
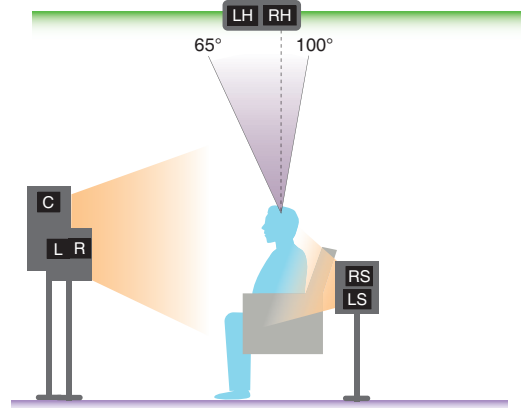

Figure 19. Speaker 5.1.4 Setup

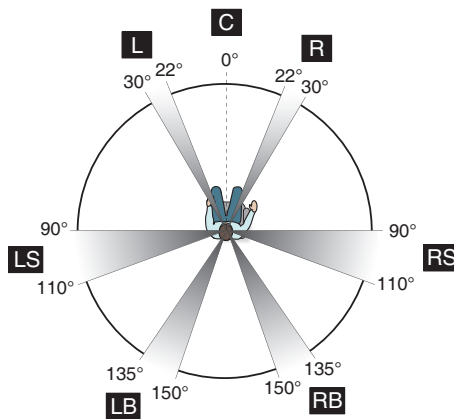
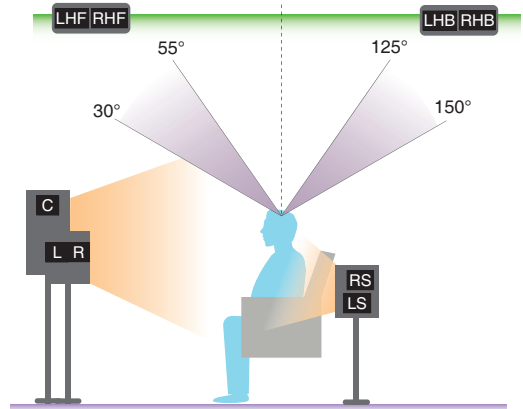
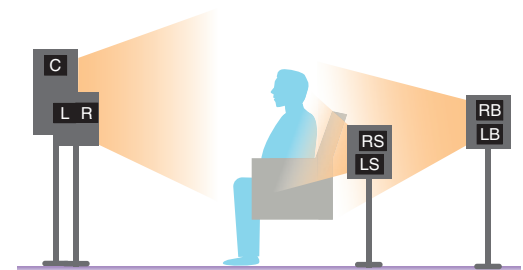

Figure 20. Speaker 7.1 Setup



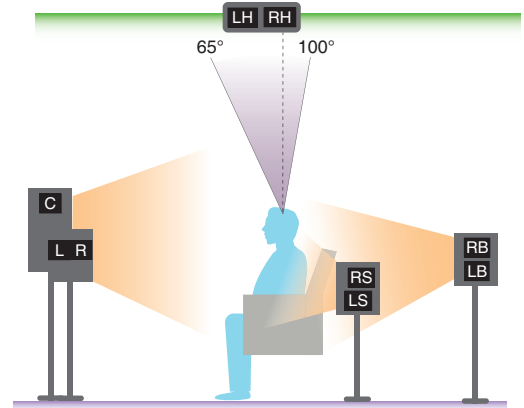
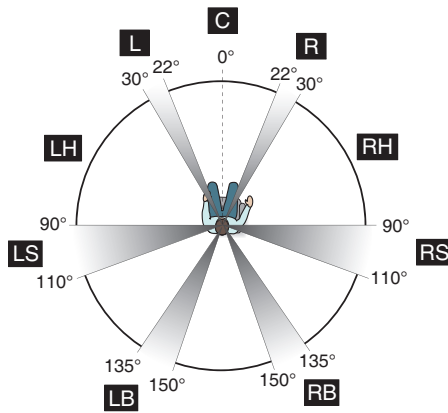

Figure 21. Speaker 7.1.2 Setup

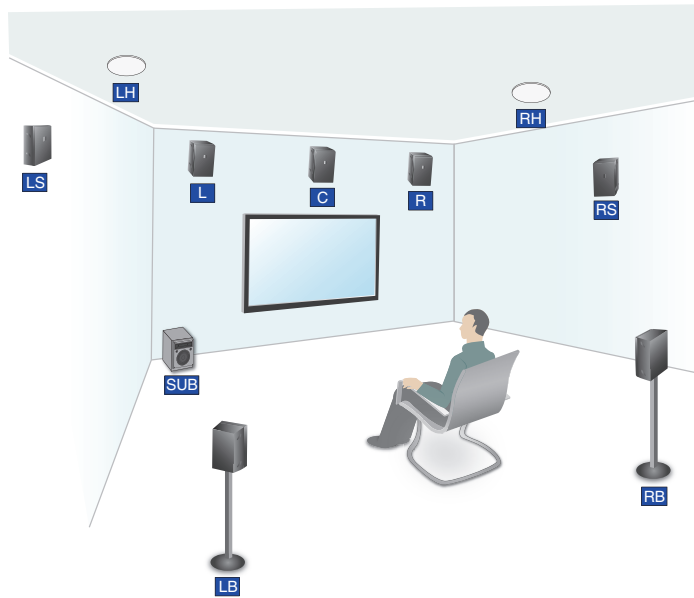

Figure 22. Subwoofer Placement

NOTES:

- To produce a good bass response, the subwoofer should be located at the front of the room, somewhere between either corner and a point about one third of the way along the front wall.
- The output channel used for the Left Back speaker in 7.1 configurations is also used for the Center Back speaker in 6.1 configurations.

Back Speakers

Back speakers can only be enabled if the Surround L/R speakers are enabled. Speaker enablement can be configured within the **Speaker Configuration** tab of PCS (see [figure 37](#) on page 41).

The drop-down list of the **Speaker Configuration** tab determines whether the audio output channels for the back speakers are passed to the left back and right back (in 7.1 setups) or to a center back (in 6.1 setups).

To enable a configuration utilizing a center back speaker, the Center and Surround L/R channels must be enabled, and the Height/Downmix channel must be disabled.

If the two speaker option is selected, then source formats with discrete or matrix mixed 6.1 encoded channels outputs the back channel signal to both the left and right back channels equally.

By default, the back speaker option is set to **2 Speakers**.

Bass Management

Low frequency sound is usually better handled by the subwoofer. Bass management creates the subwoofer channel by separating the low frequency information from the satellite speakers at a user-defined crossover point. This is summed with the Low Frequency Effects (LFE) information encoded in the source format. When no subwoofer is present, subwoofer content is sent to speakers set to **Full Range** (excluding the center speaker).

Speaker Settings

This feature sets bass management on or off for a particular speaker, defining the frequency range output by that speaker (see [figure 37](#) on page 41). These settings also enable or disable the subwoofer and set the crossover frequency.

- Left and right front speakers and left and right surround speakers are set in pairs.
- The center speaker is set as an individual speaker.
- Back speakers can be set as a single speaker or as a pair of speakers, depending on the system configuration.

Bass Management

Small speakers are those which are set to **Bass Management**. The output to each speaker (other than the subwoofer) is limited to frequencies above the crossover frequency. By default, center, surround, and back speakers are set to **Bass Management**.

Full Range

Large speakers are those which are set to **Full Range**. The full range of audio frequencies from the audio source is fed through the output of each individual channel. By default, front speakers are set to **Large**.

Subwoofer

This option allows the subwoofer to be enabled or disabled. When the subwoofer is enabled, the signal contains filtered low frequency signals from speakers set to **Bass Management** in addition to the LFE signal from the input source. If the subwoofer is disabled, the LFE signal is mixed with the bass information of all speakers in the system that are set to **Large**, except the center speaker.

Crossover Frequency

The crossover frequency sets the boundary where the low frequency signals from designated output channels are incorporated into bass management. Low frequency signals are only taken from speakers that have been set to **Bass Management** (see **Speaker Settings** on the previous page). The bass management signal is passed to the subwoofer (if present) or speakers that have been set to **Large** (except for the center speaker) if a subwoofer is not present.

The crossover frequency can be adjusted within the range of **40 Hz** to **250 Hz**, with a default setting of **100 Hz**. Speakers set to **Bass Management** (see **Speaker Settings**) output only signals above the set frequency.

Speaker Delay Settings

There are two different signal delays that compensate for different needs (see **figure 38** on page 42).

Speaker distance delay — In a room where speakers are not equidistant from the listener, sound from the closest speaker reaches the listener before sound from the farthest speaker. This feature allows the user to enter the speaker distance value for each speaker output channel. The application calculates the delay values for the closest speakers, up to **700 ms**, so that all audio arrives at a central location (the “sweet spot”) at the same time.

Lip sync offset — Video delays occur due to changes in programming from a source (TV, cable, satellite, or Blu-ray player) and also if the video signal has to be processed through another device between the source and the display. The lip sync offset feature allows the user to delay the audio sent to all output channels so that video and audio output are synchronized.

Since each source may need a different level of compensation, the lip sync offset for each input is independently adjustable from **0.0** to **300.0 ms**. Apply lip sync offset to the audio until what is heard matches what is seen on the display.

Configure these settings using PCS (see **Layouts and Speakers** on page 78).

Test Signals

Test signals are used during setup to calibrate the level for each channel and to ensure proper connection between the individual output channels of the SSP 200 and the line level input channels of an audio signal processor, a receiver with built in amplifier, or a stand alone amplifier that powers the loudspeakers.

The three options for test signal source are **Pink Noise**, **Dolby Noise**, and **Active Input**. By default, the test signal is switched **Off** (see **figure 39** on page 44).

Pink Noise — Pink noise is a signal generated by the SSP 200 that provides equal energy per octave to provide a flat response over all frequencies. The main purpose of pink noise is to calibrate the interaction of a speaker with its environment.

Dolby Noise — Dolby noise provides a bandpass-filtered noise, centered at **750 Hz** with a 12 dB/octave roll off. This signal is also generated by the SSP 200 and is used to set speakers to the same level when calibrating the room.

Active Input — This option requires an external signal source, such as a signal generator, played through the selected input source. Generally, this is a device with an analog signal output, with the SSP 200 analog input used as the active input.

Signal generators are usually used to test specific decoding mode outputs. When the **Active Input** option is chosen, the speakers that receive the test signal can be specified.

Output Channel Trim Settings

This control adjusts the output channel trim level for each output channel to match the levels to the unique needs of any listening environment. The level can be adjusted within the range from -24 dB to 0 dB. The default setting for each speaker is 0 dB (see [Test and Output Trim](#) on page 44 for more information).

Listening Mode Settings

The SSP 200 provides multiple output mode options for each supported input audio format. By default, the device selects the most appropriate output mode based upon the channel content of the input format and available output channels. This is referred to as **Auto Mode**. The user may override this mode through Product Configuration Software (PCS). For additional mode information, see [Listening Mode Options and Usage](#) on page 27.

Equalization

Each analog output channel features a nine band parametric equalizer (or EQ) that allows the control of amplitude of each band, center frequency (which can be shifted, widened, or narrowed) and bandwidth (which is labeled “Q” for quality). Parametric equalization is used to improve the audio output in a specific acoustic environment:

Resonance reduction — Reduces the level at specific frequencies that are too loud.

Speaker compensation — Compensates for peaks and dips in individual speaker output response.

Tonal enhancement — Increases the level of frequencies within a broad or narrow range that sound too quiet.

Reference

This section provides information about the following topics:

- [Source Formats](#)
- [Listening Mode Options and Usage](#)

Source Formats

Source Formats refer to how audio material is embedded on the digital program. Blu-ray and streaming content from such providers as Netflix, Hulu, and others, provide multi-channel audio tracks. While digital audio components and analog are converted to 2-channel PCM audio. The following formats from the two leading theater-surround formats come from Dolby Laboratories and DTS. Here is a list of different formats and what you can expect from them.

Audio Format	Maximum Number of Discrete Channels	Maximum Speaker Configuration	Connection with SSP 200
Dolby Digital	6	5.1	HDMI, Coax, Optical
Dolby Digital Plus	8	7.1	HDMI, Coax, Optical
Dolby Digital Plus (Atmos)	8	7.1.4	HDMI, Coax, Optical
Dolby TrueHD	8	7.1	HDMI only
Dolby TrueHD (Atmos)	8	7.1.4	HDMI only
DTS (96/24)	6	5.1	HDMI, Coax, Optical
DTS-ES	7	6.1	HDMI, Coax, Optical
DTS-HD High Resolution Audio	8	7.1	HDMI, Coax, Optical
DTS-HD Master Audio	8	7.1	HDMI only
DTS Express	6	5.1	HDMI, Coax, Optical
DTS:X	8	7.1.4	HDMI only

NOTE: The SSP 200 down mixes any format to match the configuration if the speaker configuration has fewer channels than discrete audio channels.

Dolby Digital Source Formats

These include inputs 1 to 4 only.

Dolby Digital (2/0, 2/0 Surround, 5.1, Surround EX)

Dolby Digital is a flexible, discrete, digital technology for carrying multi-channel audio. Dolby Digital supports up to six discrete audio channels; five full range front and surround channels and a band-limited LFE (Low frequency effects) subwoofer channel. Most legacy Dolby Digital formats are supported by the SSP 200 including ProLogic (I & II), EX, and 2.0. Dolby Digital formats are 16-bit with up to 48 kHz sampling.

When the SSP 200 detects this source format the Dolby **DD** LED is lit. For stereo only formats, the 2-CH LED is lit.

Dolby Digital Plus/Dolby Digital Plus Atmos

Dolby Digital Plus and Dolby Digital Plus Atmos are extensions of Dolby Digital with a higher bit rate and channel count. Dolby Digital Plus supports up to eight discrete audio channels plus encoded channels including Dolby Atmos immersive Height (ceiling) channels. The SSP 200 supports up to 12 total output channels. This is the preferred format for most streaming services.

When this source format is present, the Dolby **DD** LED is lit. If Dolby Atmos content is detected within the Dolby Digital Plus bitstream, the **ATMOS** LED is also lit.

Dolby TrueHD/Dolby TrueHD Atmos

Dolby TrueHD is a variable bitrate lossless codec, capable of supporting up to eight full-range channels (7.1) of 24-bit audio at 96 kHz. Just like Dolby Digital Plus, TrueHD Atmos content is encoded in the discrete channels. TrueHD formats offer the highest quality audio experience.

When this source format is present, the Dolby **DD** LED is lit. If Atmos content is detected within the TrueHD bitstream, the **ATMOS** LED is also lit.

DTS Source Formats (DTS)

These include inputs 1 to 4 only, unless otherwise noted.

DTS/DTS 96/24

Like Dolby Digital, DTS is a flexible, discrete, digital technology for carrying multi-channel audio. DTS supports up to six discrete audio channels; five full range front and surround channels and a band limited LFE (Low frequency effects) subwoofer channel. All DTS formats have 24-bit depth, which allows more audio information to be stored compared with the normal 16-bit depth. DTS 96/24 formats improve audio further by using the 96 kHz sampling frequency instead of the standard 48 kHz.

When this source format is present, the **DTS** LED is lit.

DTS ES (96/24, Matrix, Discrete)

Similar to standard 5.1 DTS formats, DTS ES (DTS Extended Surround) includes an additional Back channel. This sixth channel allows the user to configure mono back speakers or split it for a 7.1 configuration.

When this source format is present, the **DTS** LED is lit.

DTS-HD High Resolution Audio

DTS-HD High Resolution Audio delivers up to 7.1 channels of audio at 96 kHz sampling frequency and 24-bit resolution. DTS-HD High Resolution is implemented as a “base” DTS stream plus an extension containing two additional channels; in this way, it is compatible with legacy DTS-only encoding.

When this source format is present, the DTS LED is lit.

DTS Express

DTS Express delivers up to 5.1 channels of audio at 48 kHz sampling frequency and 24-bit resolution.

When this source format is present, the DTS LED is lit.

DTS-HD Master Audio & DTS:X

DTS-HD Master Audio adds support for lossless audio streams up to a maximum sample rate of 192 kHz at 24-bit resolution. It is also the carrier for DTS:X object-based surround sound with encoded channels providing content to Height (ceiling) speakers.

When this source format is present, the DTS LED is lit.

If DTS:X content is detected within the bitstream, the DTS:X LED is also lit.

PCM Digital Source Format (PCM)

These include inputs 1 to 4 only.

PCM source formats represent 2-channel as well as multichannel (up to 7.1) uncompressed, digital input signals. Multichannel PCM can be processed using only the HDMI input.

When the SSP 200 detects a 2-channel PCM source format, both the PCM and 2-CH LEDs light. When a multichannel PCM format is present, only the PCM LED lights.

2-Channel Source Format (2CH)

Analog

This includes input 5 only.

Any balanced or unbalanced stereo signal (or two balanced or unbalanced mono sources) is accepted. When this input is selected, the front panel 2-CH LED is active.

Digital

These include inputs 1 to 4 only.

When the SSP 200 detects any two channel digital signal (including PCM 2-channel, Dolby Digital 2/0, Dolby Digital 2/0 Surround, or DTS 2-channel) the 2-CH LED lights.

Sampling Frequency

The following table shows the most common sampling frequencies of digital inputs and the uses with which they are most often associated.

Sampling Frequency (kHz)	Use
32	Used for some cassette recordings, speech, and all other audio where smaller files are desired, with only slight compromise on sound quality. In the past, used with products such as NICAMs.
44.1	Audio CD, also commonly used with MPEG-1 audio (VCD, SVCD, MP3). Adopted from the PCM adaptor using PAL video tapes (294 lines by 3 samples by 50 frames per second).
48	Digital sound used for mini DV, digital TV, DVD, DAT, films, and professional audio.
88.2	Sampling rates used by professional recording equipment when the destination is CD (multiple of 44.1 kHz).
96	DVD-Audio, some LPCM DVD tracks, DTS 96/24, and DTS 96/24 ES Matrix 6.1 source formats always output this sampling frequency.
192	Blu-ray and HD-DVD, Dolby TrueHD and DTS-HD Master Audio output this sampling frequency when there are six discrete channels.

Listening Mode Options and Usage

Listening Mode Options

The SSP 200 listening modes allow users to upmix or downmix audio content to match their speaker configuration. By default, all listening modes are set to **Auto**. The auto setting maximizes source formats to the required speaker configuration based on what is available in the room. For example, Dolby Atmos or DTS:X downmixes to 5.1 if there are only 5 full range speakers and a sub-woofer in the speaker configuration.

Source formats that natively use fewer speakers such as an analog source or the original 5.1 release of older DVDs can be upmixed so all of the speaker channels are utilized.

Auto

The SSP 200 selects an appropriate output mode based on input format and available output channels. The encoded channels pass through to the outputs if the required output channels have been enabled in the speaker configuration. Otherwise, the encoded channels are downmixed accordingly.

Stereo

This mode plays a stereo source in its pure, unprocessed form. Multichannel formats are downmixed to a stereo output signal.

Mono

This mode plays mono source material or stereo source material that has been mixed to a mono form. It can be used to downmix a multichannel source format into a single mono output signal.

Additionally, the user can select whether the mono signals are output to the center channel (**Center Only**) or a dual mono signal is sent to the right and left front channels (**Front L+R Only**). The default option is **Front L+R Only**.

Stereo to All

This mode plays stereo or downmixed stereo sources through all output pairs in the system.

Mono to All

This mode plays mono or downmixed mono sources to all outputs in the system.

Dolby Surround

The Dolby Surround upmixing engine is utilized to upmix input audio to some or all available output channels.

DTS Neural:X

The DTS Neural:X upmixing engine is utilized to upmix input audio to some or all available output channels.

Product Configuration Software

The SSP 200 surround sound processor can be configured using Extron Product Configuration Software (PCS). This section describes:

- [Downloading PCS from the Extron Website](#)
- [Using PCS Software](#)
- [Updating Firmware Using PCS](#)

Downloading PCS from the Extron Website

Visit www.extron.com to download and install the PCS software. An Extron Insider Account is required and then the PCS program can be downloaded free of charge.

NOTE: Also you can download the latest version of firmware for your product (see [Updating Firmware Using PCS](#) starting on page 58).

1. Mouse over the **Download** tab at the top of the homepage (see figure 23, ❶).

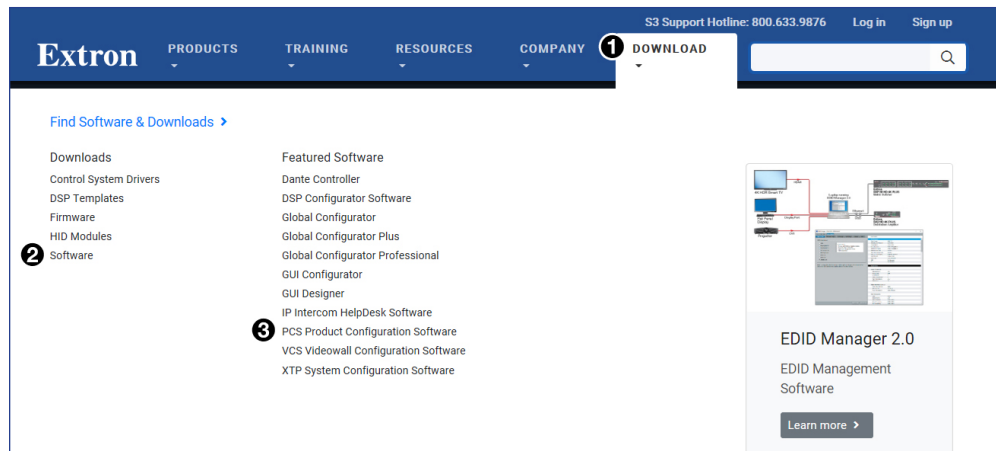

Figure 23. PCS Software Link on Download Tab

2. Click the **Software** link (❷) or, if the software is listed, click directly on the **PCS Product Configuration Software** link (❸).

The PCS window opens with the current available version (see figure 24).

Version	Release Date		Size	Release Notes
4.7	Dec. 17, 2020	<ul style="list-style-type: none">• Support for SSP 200• Ability to Disable communication on LAN port on all DXP HD 4K PLUS Devices• Ability to display Device name of mass upload related functions• Various bug fixes	253.7 MB	0.9 MB ❶ Download

Figure 24. PCS Software Download Link

3. Click **Download** (❶) and follow the on-screen instructions.

Using PCS Software

Connecting to the SSP 200

1. Ensure that PCS is installed on the control PC (see [Downloading PCS from the Extron Website](#) on page 29).
2. Connect the PC to the SSP 200 processor. PCS communicates with the SSP 200 via the front panel configuration port with a standard USB mini-B port (see [Connecting to the USB Port](#) on page 16), the rear LAN connector, or the rear panel RS-232 connector.
3. Open PCS on the PC from the **PCS** icon loaded on the desktop (optional, see image on the right) or from the **Start** menu, click **Start > Programs > Extron Electronics > Extron Product Configuration Software**.

The **Product Configuration Software** opens to the **Device Discovery** screen (see figure 25). Devices that are either networked or connected to the PC via USB are listed.

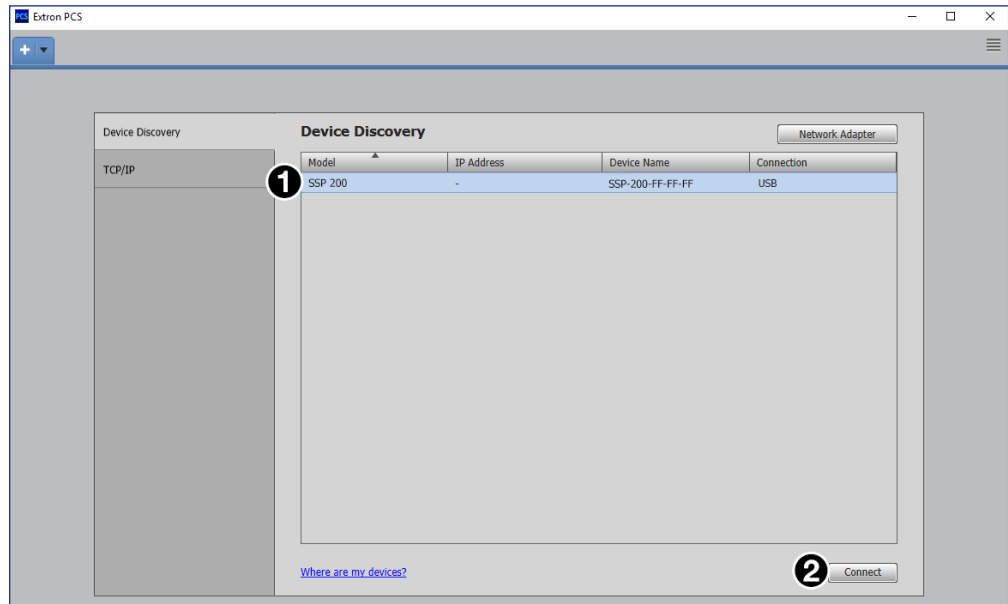

Figure 25. PCS Device Discovery Screen

4. Select the **SSP 200** device by clicking on it to highlight it in the list (1).
5. Click **Connect** (2).

The **Product Configuration Software** opens to the device main menu (see [figure 26](#) on the next page).

Main Menu

NOTE: The SSP 200 tab (top left) has a green indicator, indicating that the device connection is live.

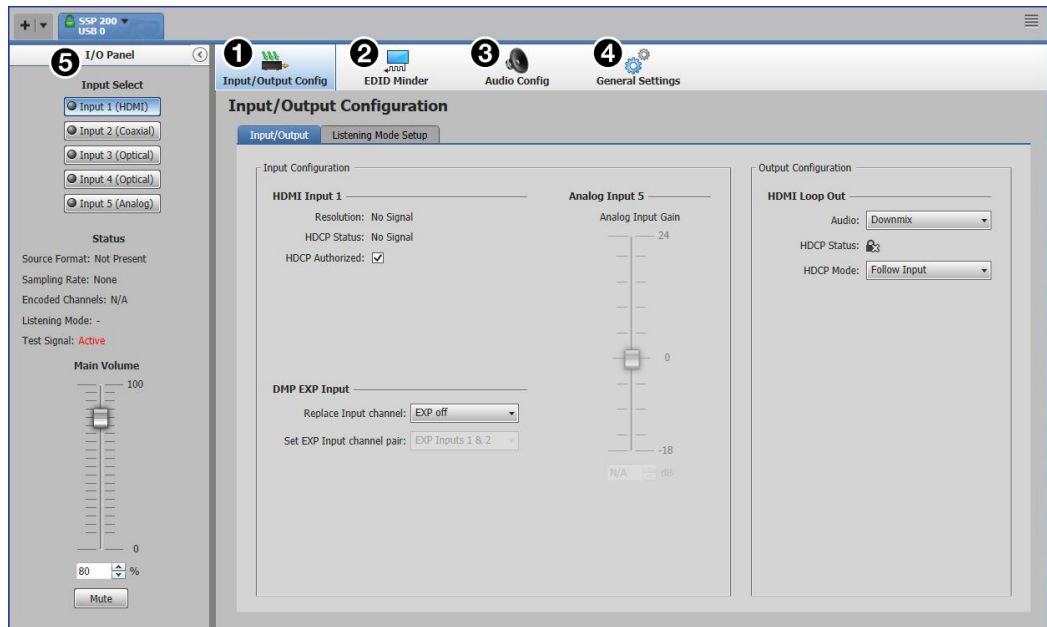

Figure 26. SSP 200 PCS Main Menu

The configuration pages have a global navigation bar from which each of the individual configuration pages can be accessed.

These tabs are:

- ① **Input/Output Config**
- ② **EDID Minder**
- ③ **Audio Config**
- ④ **General Settings**

The **I/O Panel** (⑤) is always available and can be collapsed by clicking the arrow button on the top right of the panel.

I/O Panel

The **I/O Panel** on the left side of the main window allows you to select an input and see its current status. The fader on the bottom portion is the **Main Volume**. This sets the volume level for all active speaker outputs of the SSP 200. Below the **Main Volume** fader is a **Mute** button that mutes all active speakers (see figure 27).

The master volume can be adjusted between **0%** and **100%**. The current volume setting is displayed in the text box. The volume can be changed in any of the following ways:

- Grab and drag the slider bar to adjust volume in **1%** steps.
- Click the slider bar to make it active and use the up and down arrows beside the text box to adjust the volume in **1%** steps.
- Click in the text box and type a desired volume percentage in **1%** steps. Do not type the “%” character.
- Click the slider bar to make it active and use the **<up arrow>** and **<down arrow>** keys on the keyboard to adjust the volume in **1%** steps.
- Click the slider bar to make it active and use the **<Page Up>** and **<Page Down>** keys on the keyboard to adjust the volume in **5%** steps.

The **Mute** button toggles between muting or unmuting all channel outputs.

NOTES:

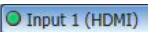
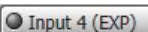
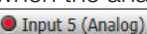
- Switching inputs disables the mute function and restores the volume setting.
- The round indicator at **Input Select** buttons 1 through 4 turn green when the input selected has an active input. 
- **Input Select** buttons 2 through 4 show **EXP** if the user configures an input to be replaced. 
- The round indicator at the **Input 5** button turns red when the analog input signal is clipping. 

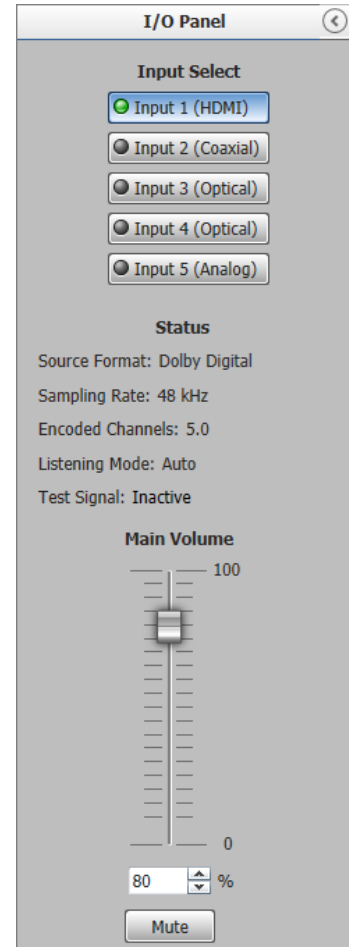

Figure 27. I/O Panel

Input/Output Config

The **Input/Output Configuration** panel allows the user to configure the active input and output signals (see [figure 28](#) on the next page).

Input Configuration

The **Input Configuration** panel allows you to view the **Resolution** and **HDCP Status** of the HDMI input and set the input to **HDCP Authorized**.

In addition, the panel allows you to enable and set the **DMP EXP Input** and adjust the gain for **Analog Input 5**.

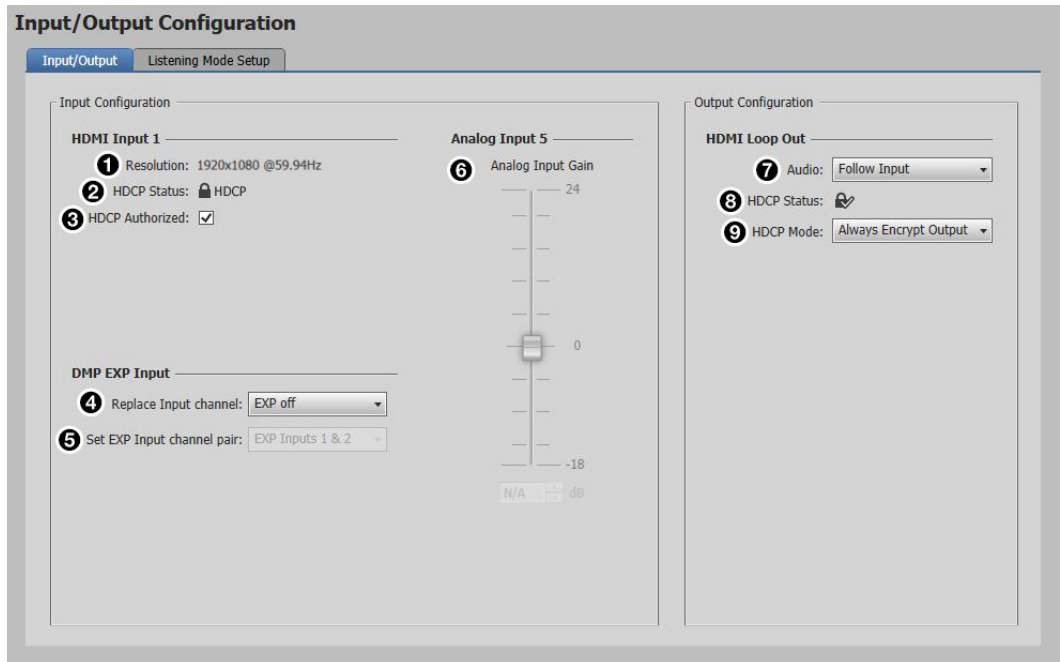

Figure 28. Input/Output Configuration Panel

HDMI Input 1

- 1 Resolution** — Displays the resolution of the HDMI input.
- 2 HDCP Status** — Indicates the HDCP status of the input source. The HDMI input negotiates and authenticates HDCP with the source device if the source requires HDCP encryption.

Symbol	Definition
	The signal is HDCP encrypted.
	The signal is not encrypted.

- 3 HDCP Authorized** — Select this checkbox to turn **HDCP Authorized** on (default) or off. When disabled (Off), the source is blocked from encrypting its output. This may result in some content not being passed to the output.

DMP EXP Input

- 4 Replace Input channel** — Enables the EXP Input by replacing one of the selectable input channels Input 2 (Coaxial), Input 3 (Optical), or Input 4 (Optical).
- 5 Set EXP Input channel pair** — Sets the EXP Input channel pair to two of the 16 possible audio channels.

Analog Input 5

- 6 Analog Input Gain** — Adjusts the gain of the signal on Input 5. When Input 5 (Analog) is selected, the **Analog Input Gain** controls are available to adjust the gain either by adjusting the fader manually or by entering a gain value in dB.

Output Configuration

HDMI Loop Out

- ⑦ **Audio** — Establishes which audio stream is routed to the HDMI Loop Out. The three options are **No Audio**, **Follow Input** audio, or the **Downmix** audio.
- ⑧ **HDCP Status** — Indicates the HDCP status of the output device. The HDMI input negotiates and authenticates HDCP with the sink device, if the sink requires HDCP encryption.
- ⑨ **HDCP Mode** — Allows the user to either **Always Encrypt Output** or to **Follow Input**. When **Always Encrypt Output** is selected, the digital input reports as an HDCP authorized sink to a source. For source devices that require encryption, enable the **HDCP Authorized** checkbox (see [figure 28](#), ③, on the previous page).

Listening Mode Setup

This panel allows you to adjust the listening mode depending on the input and source format (see [figure 29](#)).

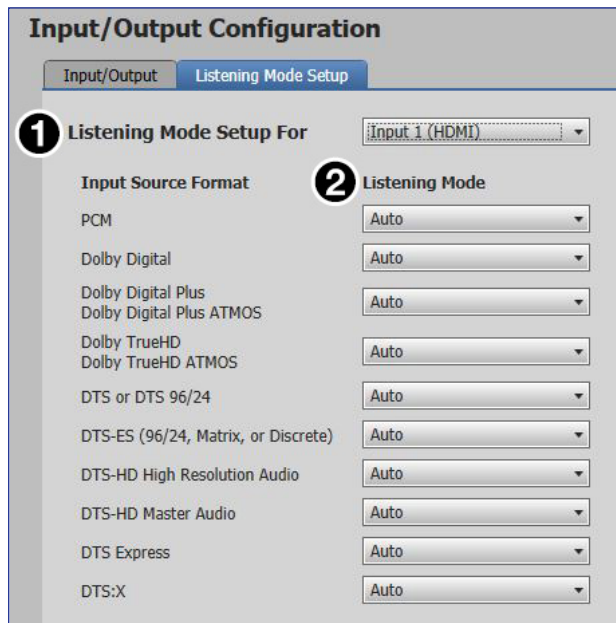

Figure 29. Listening Mode Setup

- ① **Listening Mode Setup** — This drop-down list allows you to select which input you want to set the listening modes.
- ② **Input Source Format/Listening Mode** — These drop-down lists allow you to select which listening mode you want to assign for each input source format within the selected input.

EDID Minder

EDID Minder manages the EDID information of the HDMI input. Click the **EDID Minder** tab on the global navigation bar to open the EDID Minder page.

This section includes the following:

- **EDID Minder Panels**
- **EDID Filters**
- **Adding EDID to the Favorites Panel**
- **Importing EDID to the EDID Library**
- **EDID Assignment**
- **Searching for EDID by Name**
- **EDID Report**

The EDID properties currently assigned to the HDMI input are displayed in the list of inputs. The audio input format listed in an EDID is determined by the audio input format selected on the Audio Configuration page (unless a custom EDID is used).

NOTE: If an analog custom EDID file is assigned to a digital input or a digital custom EDID file is assigned to an analog input, the display may not appear correctly.

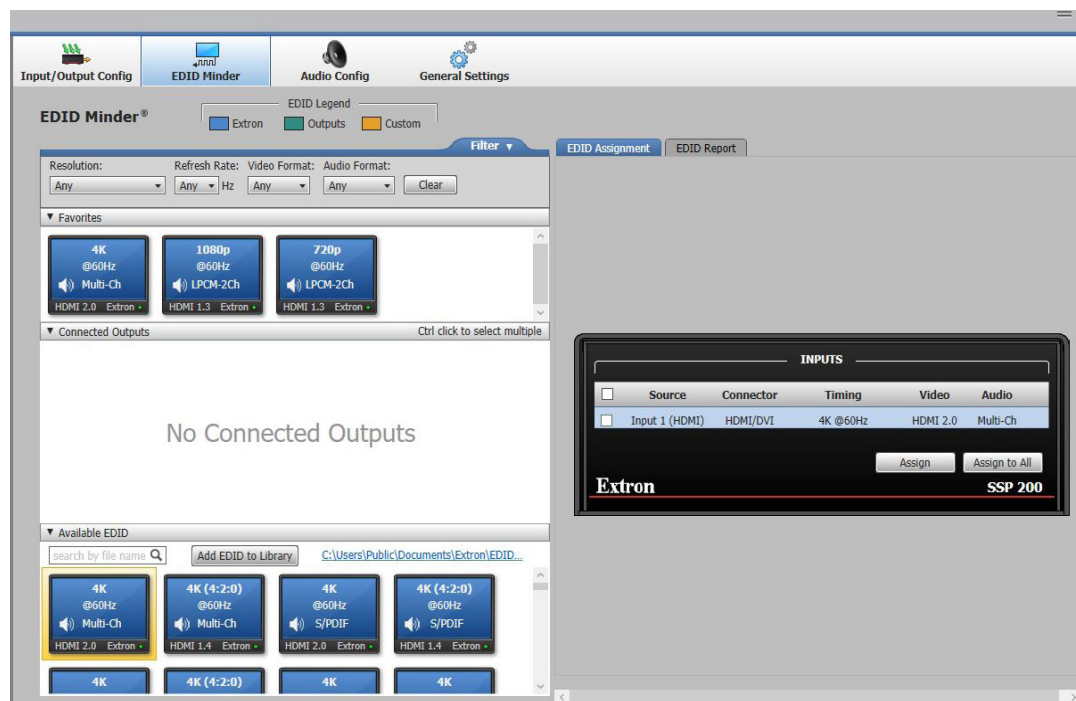

Figure 30. EDID Minder

EDID Minder Panels

- **Filter** — Displays various filters that can be enabled to easily locate specific EDID (see figure 31).

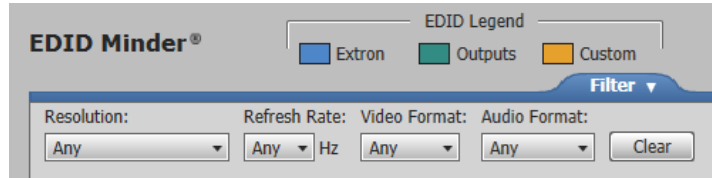

Figure 31. Filter Panel

- **Favorites** — Displays commonly used EDID which can be added to the panel for quick access (see figure 32).



Figure 32. EDID Favorites Panel

- **Connected Outputs** — Displays the EDID (color-coded green) of the output connected to the SSP 200 HDMI Thru port (see figure 33).

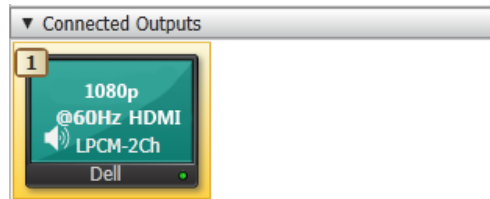

Figure 33. Connected Outputs Panel

- **Available EDID** — Displays the available EDID located on the connected unit or the local PC (see figure 34).
 - **Blue** - Extron factory-default EDID
 - **Yellow** - Custom user-saved EDID

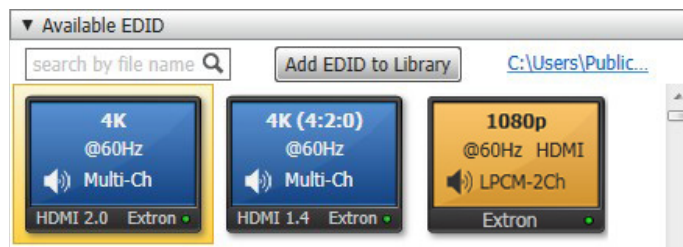

Figure 34. Available EDID Panel

- **INPUTS** — Displays the current EDID of the connected input (see figure 35).

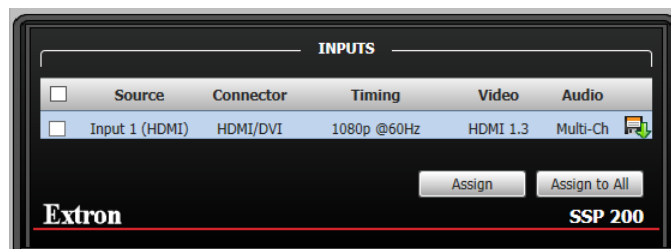

Figure 35. Inputs Panel

EDID Filters

The filters can be used to easily locate specific EDID.

Applying a Filter

1. Navigate to the **Filters** panel on the EDID Minder screen.
2. Select an EDID setting from the drop-down list of the associated filter.

The available EDID that match the filter selection are displayed in the library.

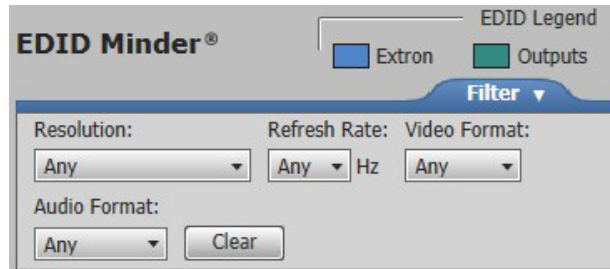

3. Repeat step 2 to apply more filters.

Clearing Applied Filters

To reset all the filters, click the **Clear** button.

Adding EDID to the Favorites Panel

Commonly used EDID can be added to the **Favorites** panel for quick access.

1. Navigate to the **Favorites** panel on the EDID Minder screen.
2. Click and drag the desired EDID to the **Favorites** panel.

The EDID is copied to the **Favorites** panel.

EDID can also be added to the **Favorites** panel by right-clicking the desired EDID and selecting **Copy**, then pasting the selected EDID into the **Favorites** panel.

Importing EDID to the EDID Library

Non-factory-default Extron EDID files can be imported into the local EDID library that is locally stored on the connected PC.

Accessing the EDID library

1. On the EDID Minder screen, navigate to the top right of the **Available EDID** panel.
2. Click the blue link (highlighted in red box).

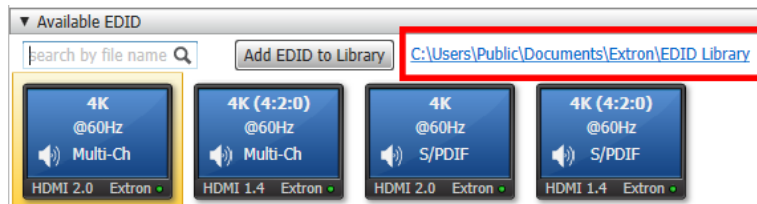

The EDID library on the local PC opens.

Accessing a non-factory default EDID into the EDID library

1. On the EDID Minder screen, navigate to the **Add EDID to Library** button to the right of the Available EDID search box.

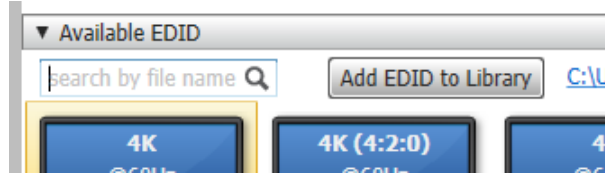

2. Click **Add EDID to Library**. The Browse Add EDID to the Library pop-up window opens.
3. Locate the previously saved EDID file (EDID files have .BIN extensions) to be added to the EDID library and click **Open**.
4. The following pop-up window displays, indicating that the EDID file was added to your EDID library. Click **Close** to continue using the software.

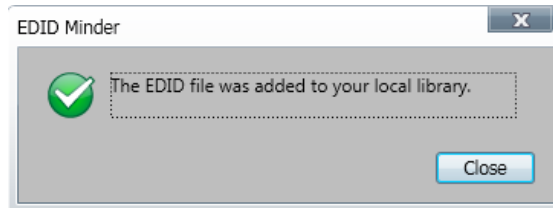

EDID Assignment

The following can be assigned to the inputs of the connected SSP 200:

- Extron factory-default EDID
- EDID from the display connected to the SSP 200 output port
- Non-factory default EDID that have been imported or saved to the PCS EDID library

Assigning a Factory-Default Extron EDID

1. Navigate to the Available EDID panel on the EDID Minder screen.

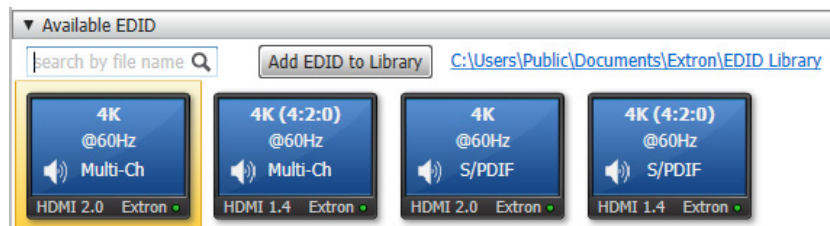

2. Select the desired EDID (represented by a blue display icon).
3. Select the check box for **Input 1** on the INPUTS panel.

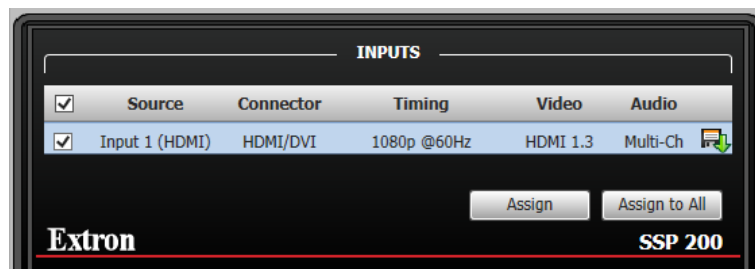

- Click **Assign**. The EDID is assigned to the input and is displayed in the **INPUTS** panel. Alternately, click **Assign to All** on the **INPUTS** panel if you would like to assign the same EDID to all inputs.

EDID can also be assigned by dragging and dropping the desired EDID directly onto the **Inputs** panel.

Assigning a Non-Factory-Default EDID

- Navigate to the **Available EDID** panel on the **EDID Minder** screen.

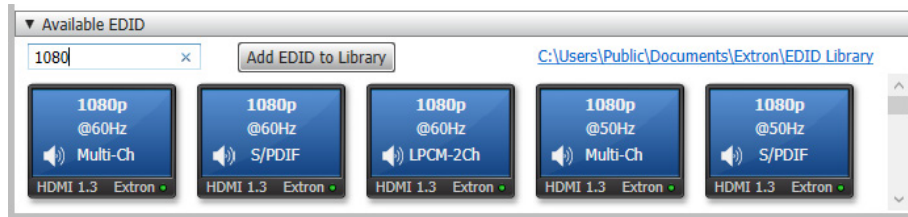

- Select the desired **EDID** (represented by an orange display icon).
- Select the check box for **Input 1** on the **INPUTS** panel.

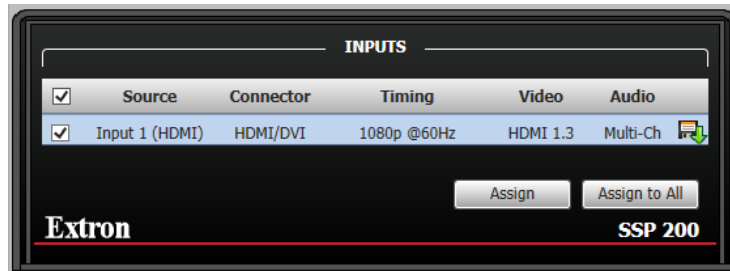

- Click **Assign**. The EDID is assigned to the input and is displayed in the **INPUTS** panel. Alternately, click **Assign to All** on the **INPUTS** panel if you would like to assign the same EDID to all inputs.

EDID can also be assigned by dragging and dropping the desired EDID directly onto the **INPUTS** panel.

Assigning EDID from a connected output

- Navigate to the **Connected Outputs** panel on the **EDID Minder** screen.

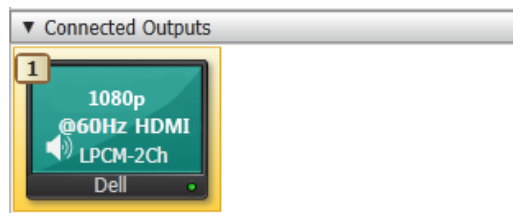

- Click the **EDID** displayed (represented by a green display icon).
- Select the check box for **Input 1** on the **INPUTS** panel.

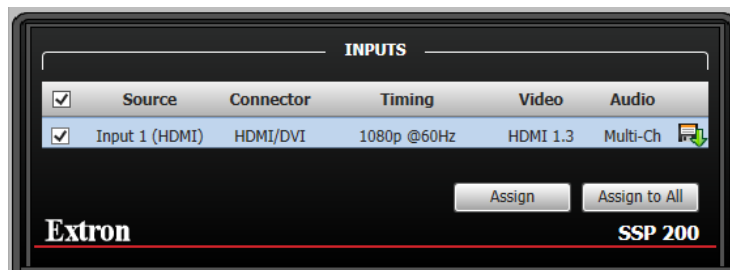

- Click **Assign**. The EDID is assigned to the input and is displayed in the **INPUTS** panel. Alternately, click **Assign to All** on the **INPUTS** panel if you would like to assign the same EDID to all inputs.

EDID can also be assigned by dragging and dropping the desired EDID directly onto the **INPUTS** panel.

Searching for EDID by Name

- On the **EDID Minder** screen, navigate to the search box located at the top of the **Available EDID** panel (highlighted in red box).

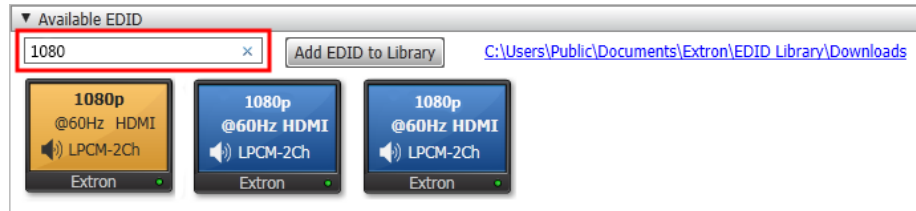

- Start typing the name of the desired EDID. Only EDID that contain the entered text are left in the **Available EDID** panel.

EDID Report

Click the **EDID Report** tab to view the translated data contained within the selected EDID file (see figure 36).

EDID REPORT	
EDID Summary	
Video Format	HDMI 2.0
Manufacturer/ Product ID	Extron 0000
Product Name	Extron HDMI
Native Resolution	3840 x 2160p @60 Hz
Maximum Resolution	4096 x 2160p @60 Hz
Maximum Pixel Clock	600 MHz
Max TMDS Character Rate	600 MHz
Colorspace and Sampling	RGB 4:4:4, YUV 4:2:0
Color Bit Depth	8 bits per color
Audio Type	Multi-Ch Audio
HDR	Not Supported
3D	Not Supported

Figure 36. EDID Report Tab

Audio Config

The Audio Configuration page has four tabs.

NOTE: The Audio Configuration tabs should be adjusted in the order they appear.

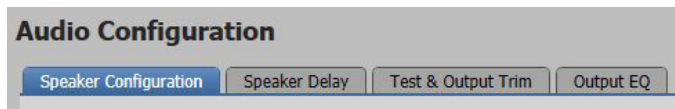

- [Speaker Configuration](#)
- [Speaker Delay](#)
- [Test and Output Trim](#)
- [Speaker Equalization/Output EQ](#)

Speaker Configuration

Click the **Audio Config** button (see [figure 26](#), [3](#), on page 31). The Audio Configuration window opens to the Speaker Configuration panel (see [figure 37](#)).

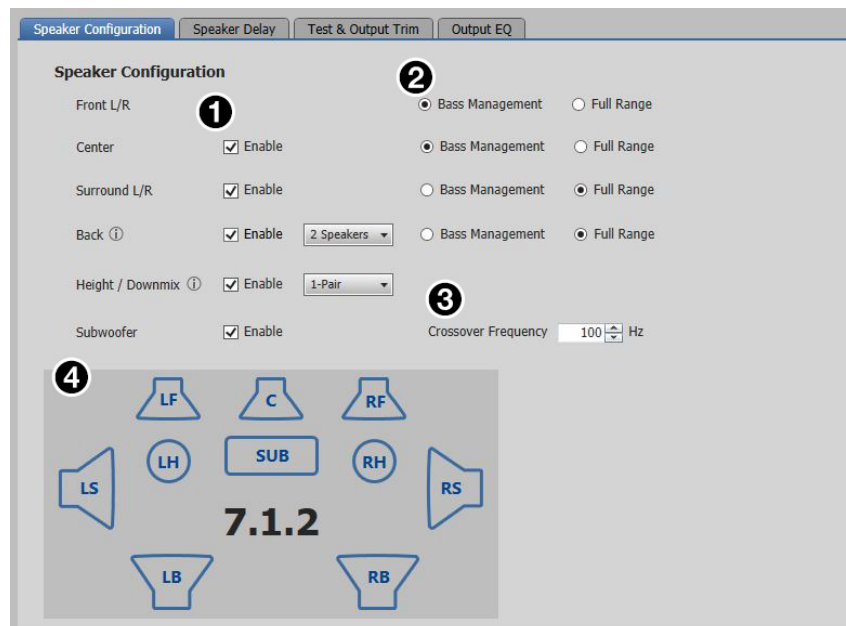

Figure 37. Speaker Configuration

The various controls can be adjusted to configure the speakers as needed.

- 1 Speaker Enablement** — This feature determines which output speaker channels are enabled and pass audio. There are additional drop-down lists for Back and Height speakers in those positions or if a stereo downmix on the analog output is required.
- 2 Bass Management/Full Range** — This selection is only enabled when its corresponding speaker channel is enabled. When **Bass Management** is selected, only frequencies above the crossover frequency threshold is sent to the corresponding speaker channels. When **Full Range** is selected, all frequencies are sent to the corresponding speaker channels.
- 3 Crossover Frequency** — When **Bass Management** is selected for a particular channel, the frequencies below this threshold are sent to the subwoofer channel (or **Full Range** speaker channels when the subwoofer channel is disabled) and the frequencies above this threshold are sent to the speaker channel.

- 4 **Configuration Display** — This graphics box shows which speaker channels are active (see [figure 37](#) on the previous page). Only the speakers enabled are displayed. If **Full Range** is selected for a particular channel then the speaker is represented by a large icon. If **Bass Management** is selected for a particular channel then the speaker is represented by a small icon.

Speaker Delay

These controls introduce a signal delay for each enabled speaker (see [figure 38](#)). The two main reasons to adjust the signal delay are:

- To compensate for unequal distances between the speakers and the listener, which causes sound from different speakers to reach the listener at different times.
- To compensate for a lack of coordination between the audio and the accompanying video signal.

Audio Configuration

Speaker Configuration | **Speaker Delay** | Test & Output Trim | Output EQ

Speaker Distance

Left Front: 0.0 ft | Center: 0.0 ft | Right Front: 0.0 ft

Left Surround: 0.0 ft | Left Height: 0.0 ft | Subwoofer: 0.0 ft | Right Height: 0.0 ft | Right Surround: 0.0 ft

Left Back: 0.0 ft | Right Back: 0.0 ft

Unit of Measure:
 Feet (ft)
 Meters (m)
 Milliseconds (ms)

Cancel | Apply

Lip Sync Offset

Input	Offset
Input 1 (HDMI)	0.0 ms
Input 2 (Coaxial)	0.0 ms
Input 3 (Optical)	0.0 ms
Input 4 (Optical)	0.0 ms
Input 5 (Analog)	0.0 ms

Milliseconds of Delay (Max = 300.0 ms)

Calculated Delay

Left Front	0.0 ms	Center	0.0 ms	Right Front	0.0 ms
Left Surround	0.0 ms	Left Height	0.0 ms	Subwoofer	0.0 ms
		Right Height	0.0 ms	Right Surround	0.0 ms
		Left Back	0.0 ms	Right Back	0.0 ms

Figure 38. Speaker Delay

Speaker Distance

When speakers are arranged in a room, there is a central location or “sweet spot” that offers the best listening point. However, even in that central location, the speakers are not necessarily all equidistant from the listener, and the sound from the closest speaker reaches the listener before the sound from speakers that are further away.

Speaker distance settings delay the signals going to each individual speaker (from 0 to 700 ms) so that the signals from all the speakers are synchronized and reach the listener simultaneously. The default setting for each speaker is 0 ms.

Speakers that are not available in the current configuration are not displayed. When the back surround is set to one speaker, the right back speaker is unavailable and the left back speaker is renamed as the center back.

Use PCS to set speaker delays, using either of the following methods.

Two Person Setup

NOTE: Setting up speaker delays is easier with two people. If only one person is available, the position of the ears of the listener must be marked precisely. A pile of boxes could be used to ensure that the distances are consistently measured to the correct height. Do not try to guess ear positions, as this introduces measurement errors.

1. Pick an ideal central location where all speaker output signals converge.
2. Use a tape measure to measure the distance from each speaker to the convergence location. Be sure to measure to the same spot from each speaker.

NOTE: Measurements from the speaker must be to the midrange driver in a three-way speaker or from halfway between the tweeter and the woofer in a two-way speaker. Measurements to the convergence location must be at ear height.

3. In the **Unit of Measure** box, click the **Feet (ft)** or **Meters (m)** radio button to select the units and enter the **Speaker Distance** values for each speaker in the boxes. The up and down arrows increase the distance in increments corresponding to steps of **0.1 ms** (**0.12 feet** or **0.03 meters**). The software automatically determines the farthest speaker and calculates the delay time (in milliseconds) for each speaker.

These values are shown in the **Calculated Delay** box. The current values are shown in blue, changes (yet to be saved) are shown in orange.

4. After all of the speakers have their measurement entered, the **Apply** button appears. Click the button to save the changes. The new values (previously in orange) are shown in blue as the current values and there are no values displayed in orange.

To retain the original values, click **Cancel** instead of **Apply**.

Setup with a Real Time Analyzer (RTA) calibration tool

1. Choose an ideal central location on which all speaker output signals converge.
2. Place the microphone from the RTA at ear level in the convergence location.
3. Select **Active Input** on the **Test & Output Trim** tab (see [figure 39](#) on the next page).
4. Play the audio source. This can be an analog source, provided by the RTA.
5. Use the **Test Signal Output** buttons in the **Test & Output Trim** tab to select which speakers are tested and the order in which the speakers are tested.
6. Use the RTA to measure the speaker distance (in ms) for each channel.
7. In the **Unit of Measure** box on the **Speaker Delay** tab, select the **Milliseconds (ms)** radio button and enter the values for each speaker (in ms) into the boxes. The up and down arrows increase the distance in increments of **0.1 ms**.

These values are shown in the **Calculated Delay** box. The current values are shown in blue, changes (yet to be saved) are shown in orange.

8. Repeat steps 5 through 7 until the speaker distance has been entered for all available speakers.

NOTE: The maximum allowable distance for the furthest speaker is **700 ms**

9. Click **Apply**. New values are shown as the current values, in blue. No values are displayed in orange.

To retain the original values, click **Cancel** instead of **Apply**.

Lip Sync Offset

Lip sync offset compensates for a lack of coordination between the audio and the accompanying video signal. This frequently occurs if the video signal has undergone complex manipulation that can delay it several milliseconds relative to the audio signal.

Since some sources may require more manipulation than others, the **Lip Sync Offset** is set for each source individually to synchronize the audio for that source with the corresponding video signal.

Enter the appropriate value for each input in the corresponding **Lip Sync Offset** box. This delay is added to every available speaker to resynchronize the video and audio signals.

Test and Output Trim

Click the **Test & Output Trim** tab to access the various output controls (see figure 39).

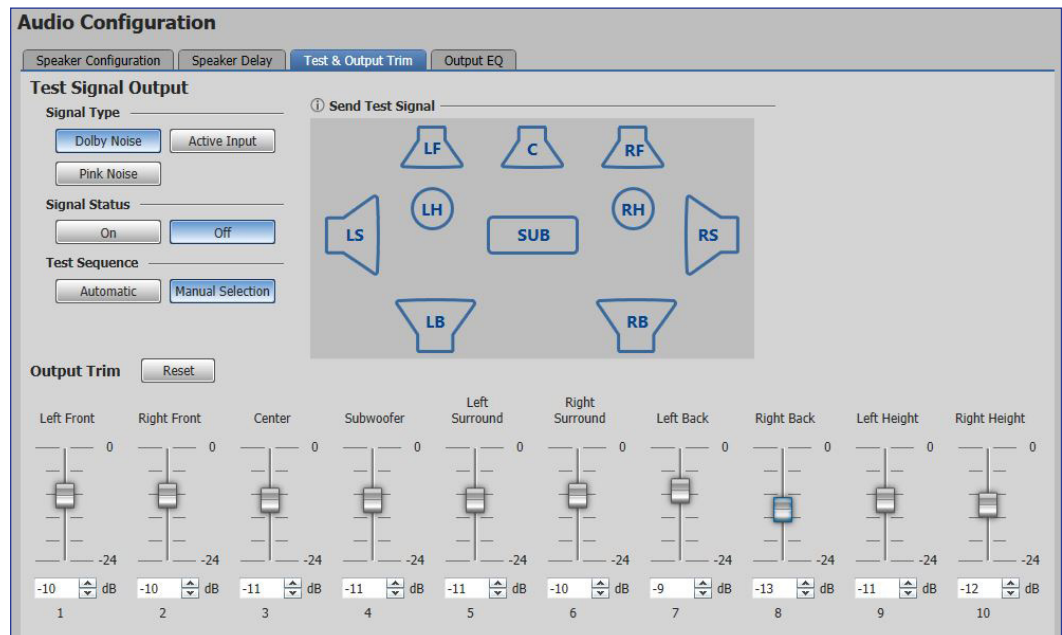

Figure 39. Test and Output Trim

Several factors can affect the sound level reaching the listener from different speakers. These factors include the distance from the speaker to the listener, slight variations between the output channels of a single amplifier, and variations between the individual speakers. Use the output trim to set the output level of each individual channel to compensate for all these variations and ensure that the sound level reaching the listener is the same from all speakers.

This page also provides a test signal utility.

Test Signal Output

Test signals are used during setup to calibrate the level of each channel and to ensure proper connection between the individual output channels of the SSP 200 and the line level input channels of an audio signal processor, a receiver with a built in amplifier, or a stand alone amplifier that powers the loudspeakers.

Selecting test signal source

There are three test signal options: **Dolby Noise**, **Pink Noise**, or **Active Input**. They are selected from the mutually exclusive **Signal Type** buttons. The **Dolby Noise** and **Pink Noise** test signals are generated by the SSP 200.

NOTE: If the active input is selected as the test signal, then its listening mode is set to **Mono** to **All** when the test sequence is active. Its listening mode is automatically restored once the test sequence is set to **Off**.

Selecting speakers to be tested

The speakers enabled in the speaker configuration are displayed in the **Send Test Signal** panel. Speakers that are not enabled are not displayed. Clicking on a speaker within the graphics box selects or deselects it from the list of speakers to be tested. For an example, the Right Back (RB) speaker in the illustration below has been deselected.

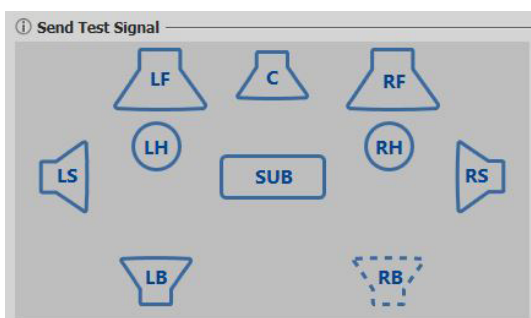

Speaker test sequence

To run an automatic test sequence:

1. Select the **Automatic** button.
2. Select the **On** button to start the test sequence. This sends the selected test signal to each speaker channel individually. Each speaker channel receives the test signal for two seconds before the test signal is routed to the next channel in the sequence. In the example below, the Left Surround (LS) speaker is shown currently receiving the test signal.

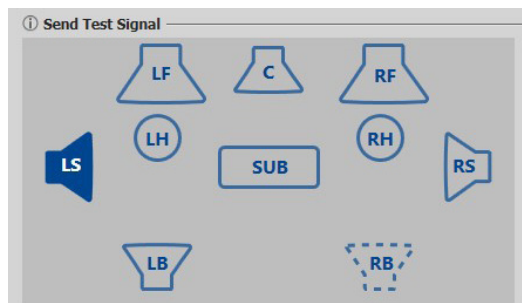

3. Select the **Off** button to switch off the test signal and end the test sequence.

To test the speakers manually:

1. Select the **Manual Selection** button.
2. Select the **On** button to start the test sequence.
3. Select a speaker in the graphics box to route the test signal to that speaker channel.
4. Select the **Off** button to switch off the test signal and end the test sequence.

NOTE: Enabling the global Mute in the I/O Panel disables an active test sequence.

Output Trim

The **Output Trim** sliders control the audio signal level for each individual channel output. Only channels that are enabled in the current speaker configuration are available. Output trim is adjustable from **-24 dB** to **+0 dB**. The current value for each output channel is shown in the text box.

Extron recommends using a Sound Pressure Level (SPL) meter to set the output trim for each speaker:

1. Set up the SPL meter at the sweet spot in the room.
2. Send a test signal, generated as described in **Test Signals** on page 22, to each individual speaker in turn. Extron recommends using the Dolby Noise signal and sending the signals to the speakers manually.

NOTE: The test signal should have a sound level at least **20** to **30** dB above ambient levels.

3. Measure and write down the sound pressure for each speaker.
4. To avoid decreasing the maximum output volume (see the note above), Extron recommends that you use the speaker with the lowest SPL reading as the zero reference point. Then attenuate all the other speakers by the required amount to balance all speakers.

In the following table, the SPL readings for five channels are given in second column. Channel 4 has the lowest reading and is used as the zero reference point. The difference between each speaker and the zero reference is calculated in column 3. This is the adjustment that must be made to the output trim for that channel.

Channel	SPL Reading	Output Trim Adjustment (dB)
1	75	-1
2	76	-2
3	79	-5
4	74	0 (zero reference channel)
5	77	-3

5. Use any of these methods to adjust the output trim for each speaker.
 - Grab and drag the slider bar to adjust output trim in 1 dB increments.
 - Click the up and down arrows besides the text box to adjust it in 1 dB increments.
 - Click one of the output trim slider controls to activate it and use the **<up arrow>** and **<down arrow>** keys on the keyboard to adjust it in 1 dB increments.
 - Click one of the output trim slider controls to activate it and use the **<Page Up>** and **<Page Down>** keys on the keyboard to adjust it in 5 dB increments.
 - Highlight the value in the text box, type a number (omit the dB), and press **<Enter>** on the keyboard.

The **Reset** button returns the output trim values for all speakers to the default value (0 dB).

Speaker Equalization/Output EQ

The **Output EQ** tab brings up the **Speaker Equalization** that provides nine parametric EQs for each output channel (see figure 40).

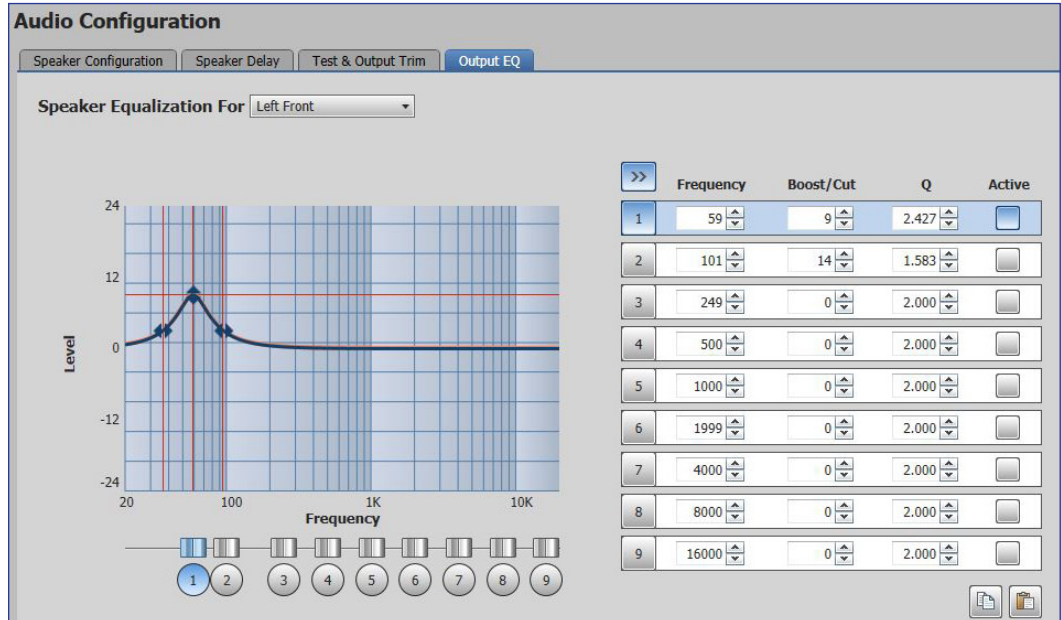

Figure 40. Speaker Equalization/Output EQ

The default frequency values correspond to a nine-band graphic equalizer, which provides a starting point for refining the output signal from each speaker channel.

All the properties of the SSP 200 parametric filters can be adjusted by the user.

The numbers are used to select the filters for utilizing the copy/paste function or to change the focus on the graph to the left. Filters are automatically selected when a parameter is adjusted.

The **Active** column has toggle buttons for activating (or unbypassing) a filter. A filter only affects the signal if it is active (blue).

Speaker Selection

To begin the adjustment, first select the speaker to be configured from the **Speaker Equalization For** drop-down list.

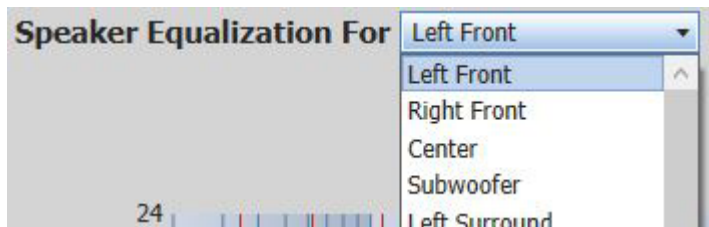

Figure 41. Speaker Selection

Filter Parameters

These four fields (on the right side of the page) control the parameters that can also be adjusted in the graph.

- **Filter number** — Selects a filter to display on the graph or copy and paste functionality.
- **Frequency** — Adjusts the center frequency of the filter.
- **Boost/Cut** — Adjusts the amount of amplification or attenuation applied to that specific filter.
- **Q** — Adjusts the bandwidth to where the boost or cut is applied. As the Q value increases, the bandwidth becomes narrower.

NOTE: When values are altered in the filter parameter fields, the graphic display is updated to reflect the changes.

Modifying Filter Parameters

The graph in the **Filter** dialog box displays a graphical representation of the selected and composite filters.

- An orange line indicates the composite curve of all active filters.
- A blue line indicates the selected filter.
- Inactive filters do not contribute to the orange composite curve. However, when selected, an inactive filter appears as a dotted line independent of the composite curve.

To modify Frequency

1. In the **Filter** dialog box, select the filter to be modified. To do so, either click the filter number at the left of the **Filter** menu (figure 42) or click the appropriate **Frequency** handle below the graph (figure 43).

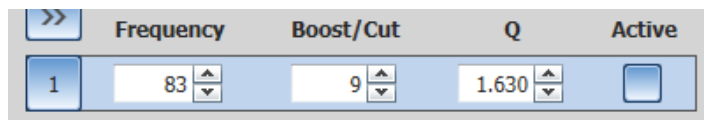

Figure 42. Filter Menu

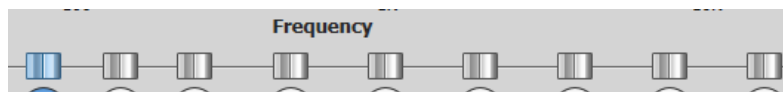

Figure 43. Frequency Handles

2. Click and drag the **Frequency** handle left or right to desired position or value. Alternatively, enter the value in the **Frequency** field for the selected filter, or click the up or down arrows next to the field until the desired value is displayed.

To modify Boost/Cut (Parametric):

1. In the **Filter** dialog box, select the filter to be modified. To do so, either click the filter number to the left of **Filter** menu or click the appropriate **Frequency** handle below the graph.
2. Click and drag the **Boost/Cut** handle, located at the center frequency in the graph (see [figure 44](#) on the next page), up or down to the desired position or value. Alternatively, enter the value in the **Boost/Cut** field for the selected filter, or click the up or down arrows next to the field until the desired value is displayed.

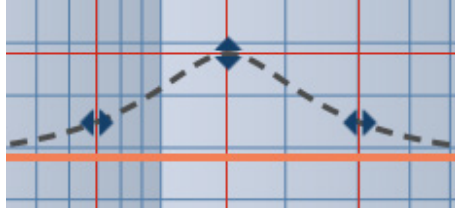

Figure 44. Center and Outer Handles

To modify Q (Parametric filters):

1. In the **Filter** dialog box, select the filter to be modified. To do so, either click the filter number to the left of **Filter** menu or click the appropriate Frequency handle below the graph.
2. Click and drag one of the Q handles within the graph, located at the lower or upper frequency on the filter curve, left or right to the desired position or value.
Alternatively, enter the value in the Q field for the selected filter, or click the up or down arrows next to the field until the desired value is displayed.

EQ Filter Copy and Paste

Copy and Paste buttons are available to streamline your repeat filter settings. The buttons are located at the bottom right of the page.

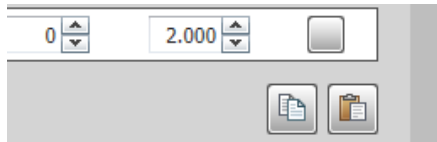

Figure 45. EQ Filter Copy and Paste Buttons

To copy and paste a setting:

1. Click a number to select filter settings to copy.
2. Click the **Copy** (📄) button.
3. Click a different filter number to paste.
4. Click the **Paste** (📄) button.

General Settings

General Settings

Click the **General Settings** button (see [figure 26](#), ③, on page 31).

The **General Settings** panel (see [figure 46](#)) allows you to adjust:

- **Dolby Settings**
- **DTS Settings**
- **Dynamic Range Compression**
- **Mono Settings**
- **Front Panel Lockout (Executive Mode)**

The **General Settings** panel also allows you to access:

- **Hardware Settings**
- **Communication Settings** (after opening the **Hardware Settings** panel)

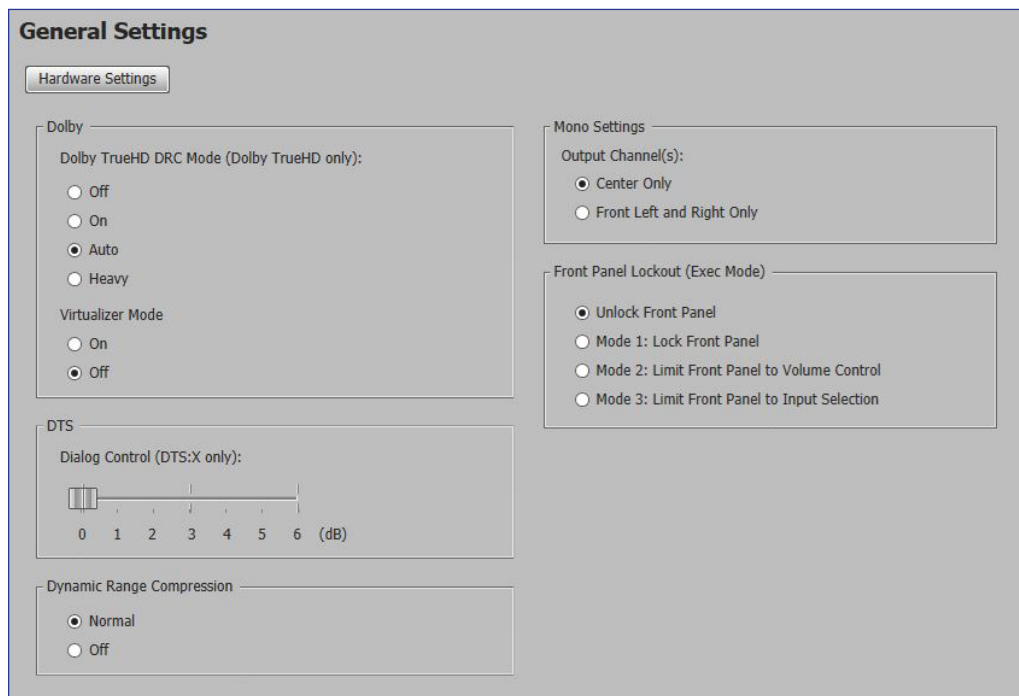
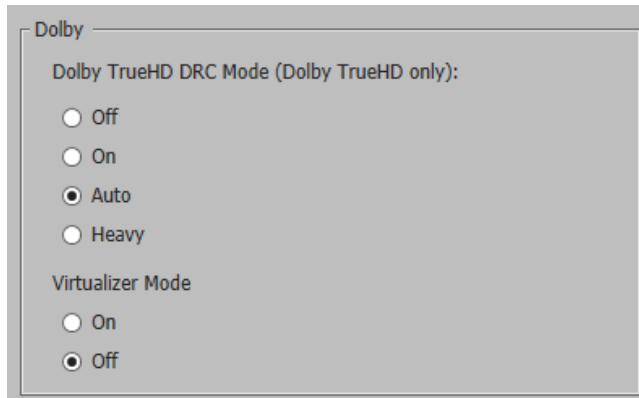

Figure 46. General Settings

Dolby Settings

Depending on the listening environment, listener preference, or both, reducing the dynamic range of an audio program may be desirable. To limit the dynamic range, Dolby TrueHD DRC Mode applies dynamic range compression to the Dolby TrueHD audio content. When dynamic range compression is applied, the high audio levels of content are cut (attenuated) and the low levels are boosted (amplified).

Using the **Virtualizer Mode** on a Dolby signal gives you the effect of a virtual height and surround effect from traditional speaker layouts without the use of height speakers in systems with more than 2 channels.



DTS Settings

The DTS Dialog Control setting determines the amount of gain increase (in dB) for the dialog audio tracks in a DTS:X stream. This is useful for movies where the dialog is perceived as too quiet when compared to the music or score.

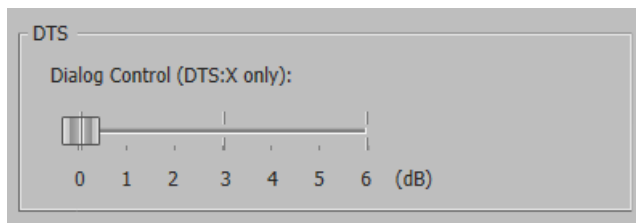

Dynamic Range Compression

This setting determines the amount of compression applied. This setting does not apply to Dolby TrueHD streams.

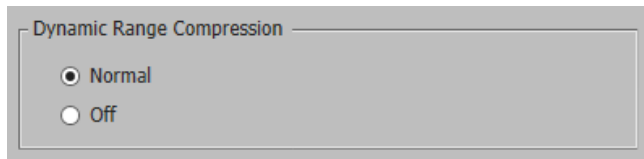

Mono Settings

This setting determines how the SSP 200 outputs its mono channels when a mono listening mode is selected, either the center channel or both the front left and right only.

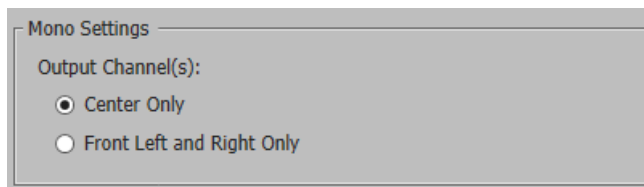

Front Panel Lockout (Executive Mode)

This setting determines what functionality is available on the front of the device.

- **Unlock Front Panel** — Allows all of the buttons to operate normally.
- **Mode 1** — Removes the functionality of every button on the front of the device.
- **Mode 2** — Limits front panel functionality to just volume control.
- **Mode 3** — Limits front panel functionality to just input selection.

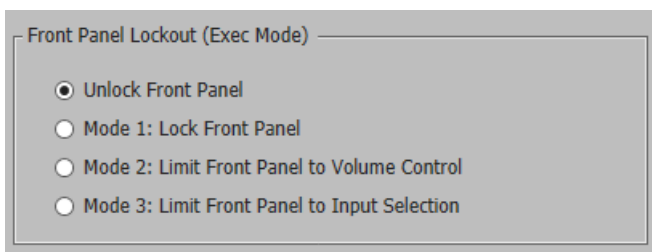

Hardware Settings

Click the **Hardware Settings** button (see [figure 46](#) on page 50) to access the Unit Information, Device Name, Date and Time, and Password panels.

Unit Information

The Unit Information panel gives a non-configurable view of information about the connected device (see [figure 47](#) on the next page).

The following device information is displayed:

- Part number
- Model name
- Model description
- Firmware version
- Temperature (inside device)
- Device name
- DHCP status
- IP address
- Subnet mask
- Default gateway address
- DNS server
- MAC address

Click **Edit Communication Settings** (1) to go to the Communication Settings panel. Click **Cancel** (2) to return to the General Settings panel.

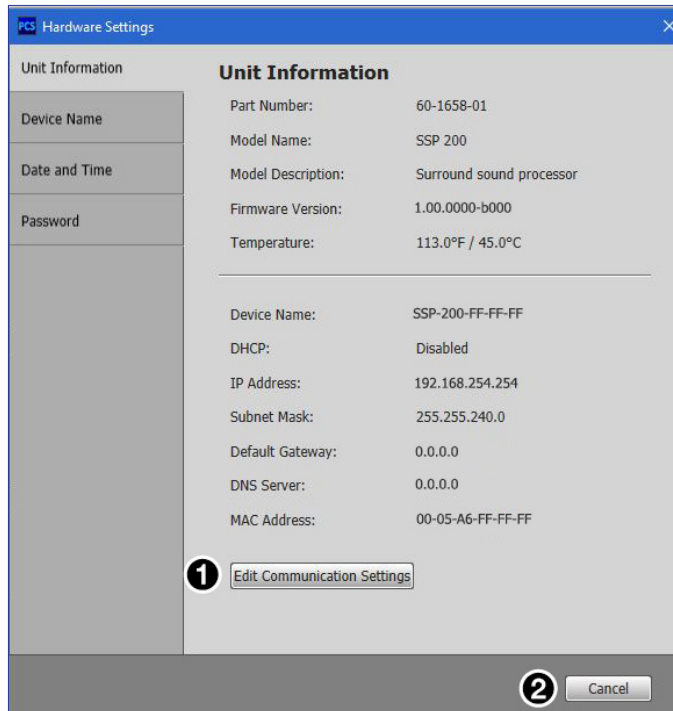

Figure 47. Hardware Settings: Unit Information

Device Name

The **Device Name** panel allows you to assign or change the name or hostname of the connected device (see figure 48).



Figure 48. Hardware Settings: Device Name

NOTE: The device name is used as the hostname of the SSP 200.

To assign or change the hostname:

1. Enter a name for the device in the name field (see [figure 48](#), **1**, on the previous page). This name can be up to 63 characters in length with no spaces between characters. Only alphanumeric characters and the hyphen are valid. The first character must be alphabetical, and the last one cannot be a hyphen (-). If an invalid name is entered, a red symbol appears to the right of the name field.
2. Click the **Apply** button (**2**) to change the name or click the **Cancel** button (**3**) to keep the previous name.
To reset the device name to the default: Click the **Reset to Default** button (**4**). The default device name consists of the model name, followed by the last three hexadecimal character pairs of the product MAC (hardware) address. All parts of the name are separated by hyphens (for example: SSP-200-FF-FF-FF).

Date and Time

1. Click the **Date and Time** button to access a menu to change the date, time, and time zone of the device (see [figure 49](#)). You can also click the **Sync to PC** button to synchronize the device with a connected computer to align the current date and time.
2. Click the **Apply** button when done. Or click **Cancel** to return to the previous menu with no changes.

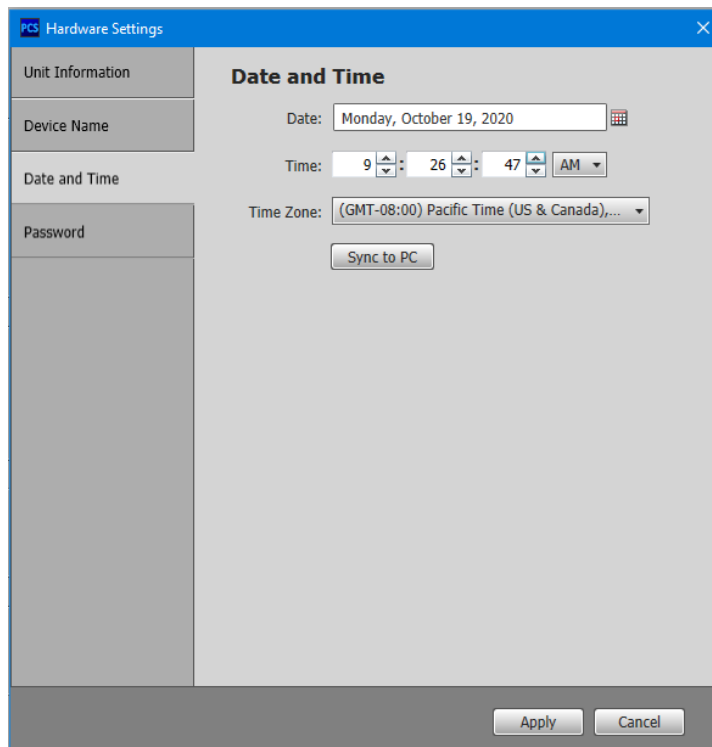

Figure 49. Hardware Settings: Date and Time

Password

The Password panel (see figure 50) allows the user to set an administrator and user password on the device. Administrators and users can view all settings on the device. Administrators have the ability to make adjustments to any setting. Users can make changes to a limited subset of settings.

The screenshot shows a web interface for setting passwords. On the left is a sidebar with 'Unit Information', 'Device Name', 'Date and Time', and 'Password'. The main area is titled 'Password' and contains two sections. The first section is for 'Login ID: admin' and has two password fields: 'Admin Password' (1) and 'Confirm Password' (2). The second section is for 'Login ID: user' and has two password fields: 'User Password' (4) and 'Confirm Password' (5). At the bottom right, there are 'Apply' and 'Cancel' buttons, with the 'Apply' button labeled (3).

Figure 50. Hardware Settings: Password

NOTES:

- A username is required to access the internal web pages or the device through the PCS program. When prompted, enter **admin** as the username for administrator passwords or **user** as the username for user passwords.
- A password can be up to **128** characters in length. All man-readable characters are permitted except "|". Password cannot be a single space. Passwords are case-sensitive.
- The factory configured passwords for all accounts on this device have been set to the device serial number. Passwords are case sensitive. If the SSP 200 is reset, the passwords revert to the default, which is **extron**.

To create or change an administrator password:

1. In the **Administrator Password** field (1), enter the desired administrator password.
2. In the **Confirm Password** field (2), reenter the administrator password.
3. Click the **Apply** button (3).

To create a user password:

NOTE: A **user** password cannot be set until an administrator password has been set.

1. In the **User Password** field (4), enter the desired user password.
2. In the **Confirm Password** field (5), reenter the user password.
3. Click the **Apply** button (3).

Communication Settings

Click the **Edit Communication Settings** button (see [figure 47, ⑥](#), on [page 53](#)) on the **Hardware Settings** panel to open the **Communication Settings** dialog box.

The **Communication Settings** dialog box (see [figure 51](#)) allows you to view and adjust device settings for RS-232 and Ethernet connections.

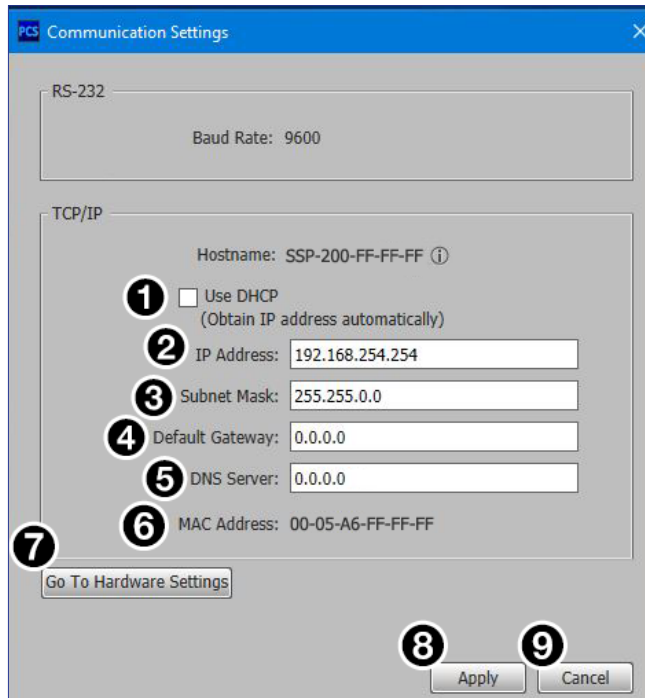

Figure 51. Communication Settings

If you do not want to implement any changes, click **Cancel** (⑨) to return to the **General Settings** panel or click the **Go To Hardware Settings** button (⑦) to return to the **Hardware Settings** panel.

The **Use DHCP** check box (①) directs the SSP 200 to ignore any entered IP addresses and obtain an IP address from a Dynamic Host Configuration Protocol (DHCP) server (if the network is DHCP capable). Contact the local system administrator to determine if this is the appropriate selection. Click the **Apply** button (⑧) to make changes take affect.

The device MAC address (⑥) is also displayed on this panel though it cannot be changed.

To configure the Ethernet settings for use with DHCP:

1. Select the **Use DHCP** checkbox (①).
2. Click the **Apply** button (⑧).

To configure the Ethernet settings with a static IP address:

1. Ensure the **Use DHCP** checkbox (①) is not selected.
2. In the **IP Address** field (②), enter an IP address.
3. In the **Subnet Mask** field (③), enter the subnet mask if required.
4. In the **Default Gateway** field (④), enter the default gateway if required.
5. In the **DNS Server** field (⑤), enter a DNS server name if required.
6. Click the **Apply** button (⑧).

To cancel changes, at any time, click the **Cancel** button (⑨) to keep the last saved settings.

Device Menu

The Device menu (see the image on the right) allows the user to:

- 1 Disconnect the device from PCS.
- 2 Open the **Hardware Settings** or **Communication Settings**.
- 3 Reset Device to factory default.
- 4 Update Firmware.
- 5 View the SSP-200 Help file.
- 6 View information About this Module.

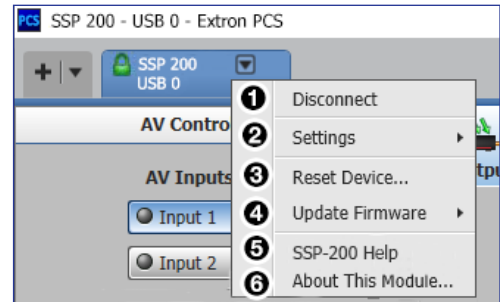

Reset Device

This function resets all device settings to factory defaults with or without retaining the TCP/IP settings.

To reset the device:

1. From the drop-down **Device** list, select **Reset Device...**. A dialog box opens (see figure 52).
2. Select from the three reset options shown in the figure.
3. Click **Reset** to perform the reset or **Close** to cancel the operation.

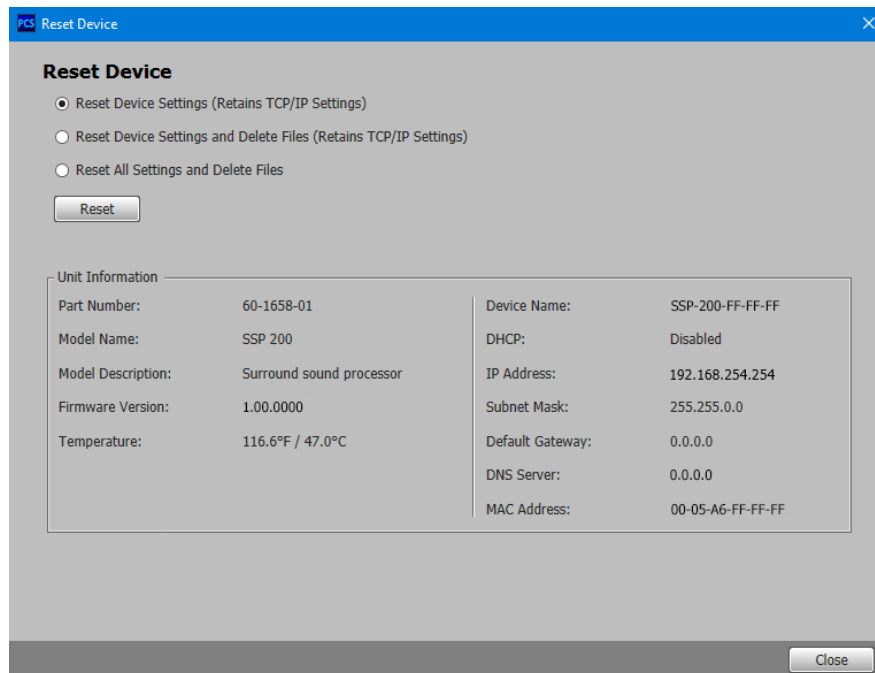
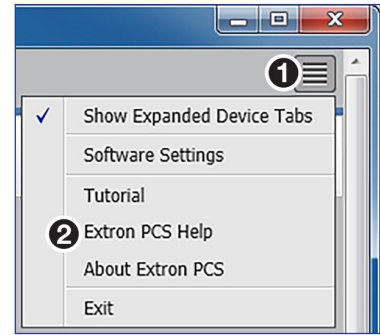

Figure 52. Reset Device

PCS Help File

For assistance, Extron PCS Help contains information about using the program to configure the SSP 200.

To access Extron PCS Help, click the button in the right corner of the PCS program screen (see the image on the right, ①) and click **Extron PCS Help** (②).



Updating Firmware Using PCS

Firmware for the SSP 200 can be updated using PCS. Updates to the SSP 200 firmware are made available periodically via the [Extron website](#). You can find out what version of firmware is currently loaded on your SSP 200 by entering the SIS Q command via the RS-232, USB, or LAN interface (see [Firmware Version/Part Number/Information Queries](#) on page 69) or listed in **Hardware Settings** in PCS (see [Hardware Settings](#) on page 52).

Downloading the SSP 200 Firmware

To download the latest version of firmware for the SSP 200:

1. Go to www.extron.com, and mouse over the **DOWNLOAD** tab (see figure 53, ①).

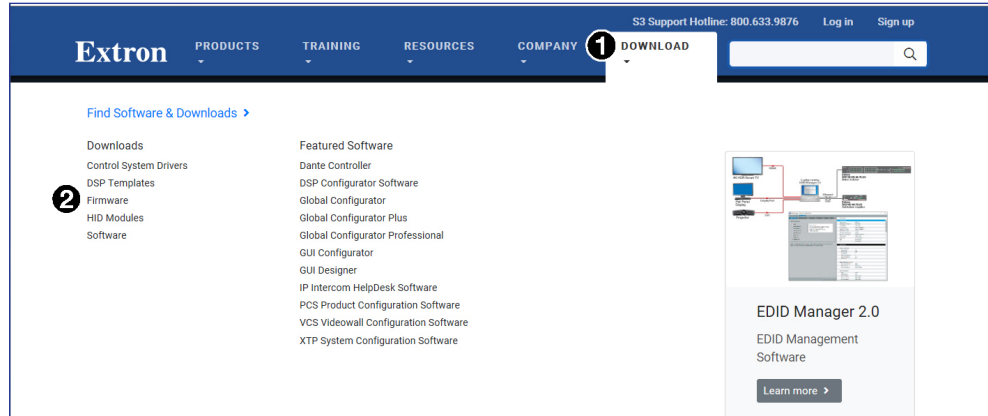

Figure 53. Download Tab

2. Click the **Firmware** link (②) from the drop-down list. The **Firmware** page opens (see figure 54).

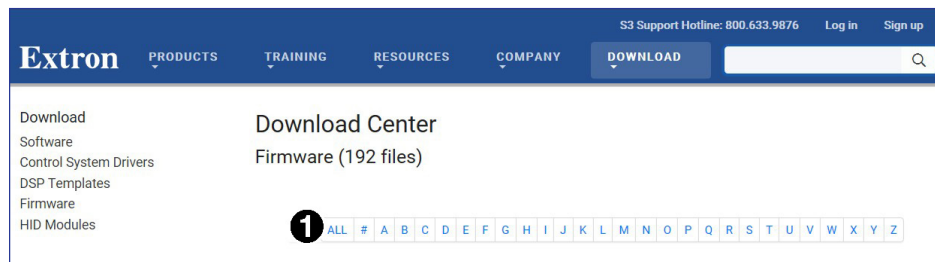

Figure 54. Firmware Page with the Alphabetic Navigation Bar

3. Click the letter **S** on the alphabetic navigation bar (①).

4. Scroll down the page until you locate the firmware for the SSP 200.
5. Click **Download**. The product download screen opens.
6. Enter the required user login information. An executable (.exe) file downloads to the PC. **Run** this program to place the firmware on the PC. Make a note of the folder where the firmware file was saved.

ATTENTION:

- The extension of the firmware file must be .eff. Opening a file with an incorrect extension may cause the device to stop functioning.
- L'extension du fichier firmware doit être .eff. Si un fichier est ouvert avec une mauvaise extension, l'appareil peut arrêter de fonctionner.

Loading the Firmware to the SSP 200

To load a new version of firmware to the SSP 200 using PCS:

1. Connect your computer to the SSP 200 via either the device rear RS-232 or LAN port (see **Rear Panel Features** starting on page 6) or the front panel USB Config port (see **Front Panel Features** starting on page 11).
2. If needed, download and install PCS to your computer (see **Downloading PCS from the Extron Website** on page 29).
3. If needed, download the latest version of SSP 200 firmware to your computer (see **Downloading the SSP 200 Firmware** on page 58).
4. Open PCS by clicking the desktop icon, if available or using your desktop **Start** menu to make the following selections: **Start > All Programs > Extron Electronics > Extron Product Configuration Software**.

The Product Configuration Software window opens to the Device Discovery screen (see figure 55).

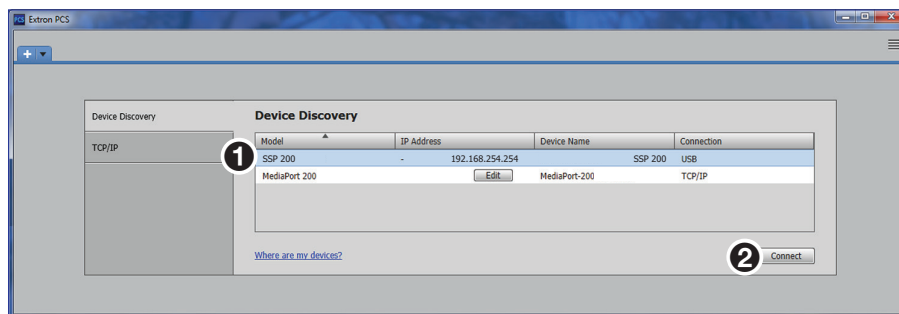

Figure 55. PCS Device Discovery Screen

5. On the Device Discovery screen, select the **SSP 200** (1).
6. Click **Connect** (2).
7. The Product Configuration Software opens to the main page (see figure 56). Click the device menu arrow next to the name of the device (1).

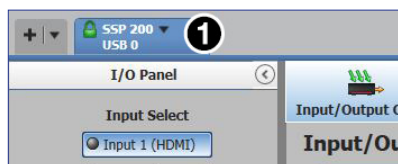

Figure 56. Accessing the Device PCS Menu

- The Device menu drops down (see figure 57). Click **Update Firmware** (1) and then **Update Firmware to this Device...** (2).

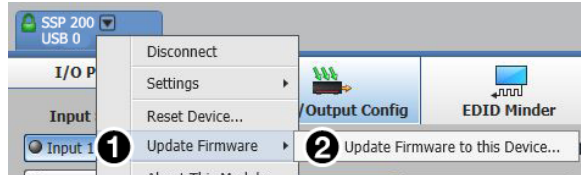

Figure 57. Update Firmware to this Device

- The Update Firmware window opens. Click **Continue** (see figure 58, 1).



Figure 58. Update Firmware Window

- The Update Firmware to this Device window opens. Click **Open Firmware File...** to locate and select the file.

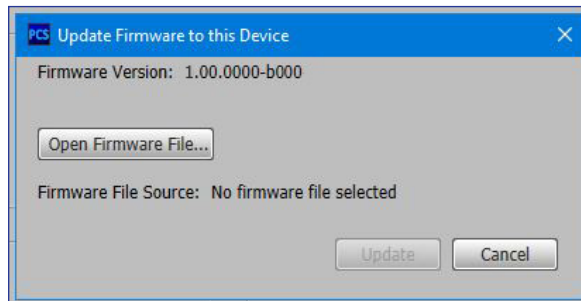

Figure 59. Update Firmware Window

- An Explorer window opens. Navigate to the firmware file that has been downloaded to the connected PC.

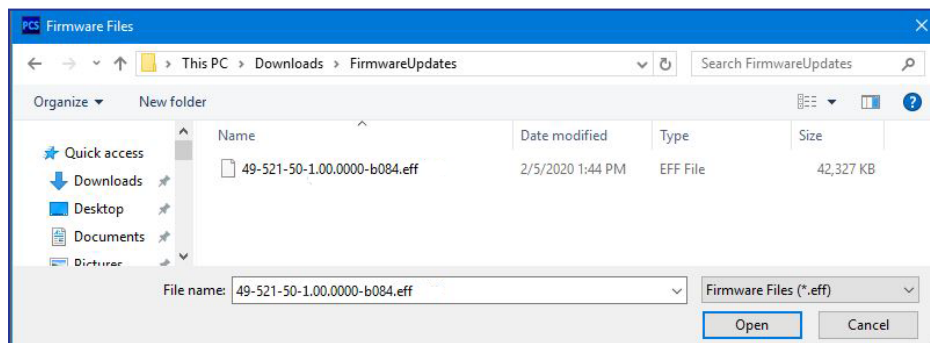

Figure 60. Select Firmware File

ATTENTION:

- Valid firmware files must have the file extension **.eff**. A file with any other extension is not a firmware upgrade for this product and could cause the SSP 200 to stop functioning.
- Les fichiers firmware valides doivent contenir l'extension fichier **.eff**. Un fichier avec n'importe quelle autre extension n'est pas une mise à jour de firmware pour cet appareil et l'appareil pourrait arrêter de fonctionner.

12. Click **Open** or double-click the firmware file.
13. Click **Update** on the **Update Firmware** dialog box (see figure 61). This uploads and verifies the new firmware onto the connected device. The **Installing Firmware** progress field shows the progress of the upload.

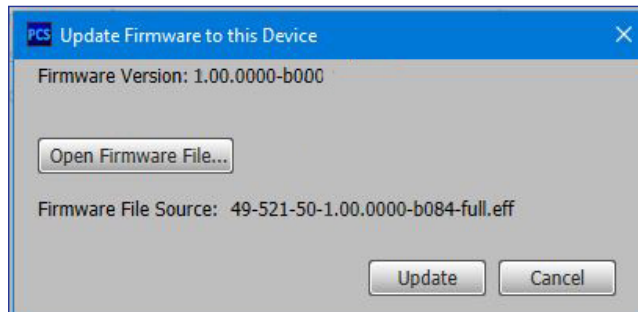

Figure 61. Update Firmware

14. After the upload is complete, a dialog box opens confirming that the update has been successful. Click **Close**. The software returns to the **Device Discovery** window (see [figure 55](#) on page 59).
15. Select the **SSP 200** from the **Device Discovery** menu. A connection must be re-established with the device before continuing to use the software.
16. Click **Connect**, or double-click the device. The device reconnects to the software.

NOTE: The original factory-installed firmware is permanently available on the SSP 200. If the attempted firmware upload fails for any reason, the device reverts to the factory version.

SIS Configuration and Control

This section describes Simple Instruction Set (SIS) command programming and control of the SSP 200, including:

- [Connection Options](#)
- [Host-to-device Communications](#)
- [Using the Command and Response Tables](#)
- [Command and Response Tables](#)

Connection Options

The SSP 200 can be configured and controlled using SIS commands or internal web pages. Configure and control the SSP 200 remotely via a host computer or other device (such as a control system) by connecting to the rear panel RS-232 port, LAN port, or the front panel USB Config port of the SSP device.

RS-232 Port

The SSP 200 has a rear panel serial port (see [figure 3](#) on page 6) that can be connected to a host device such as a computer running the Extron DataViewer utility. The port makes serial control of the SSP possible. Use the protocol information listed below to make the connection (see [Host-to-device Communications](#) on page 64).

RS-232 protocol defaults:

- 9600 baud
- 8 data bits
- no parity
- no flow control
- 1 stop bit

Front Panel Configuration Port

The USB mini-B port is located on the front panel (see [figure 10](#) on page 11). Connect to a host computer for configuration using SIS commands with DataViewer, available at www.extron.com. To connect the SSP 200 to a host computer, download the USB driver, follow the on-screen instructions, and configure the SSP as required.

Ethernet (LAN) Port

The rear panel LAN connector (see [figure 3](#) on page 6) on the device can be connected to an Ethernet LAN or WAN. Communications between the SSP 200 and the controlling device is via an SSH client using port 22023. The SIS commands and the actions of the SSP 200 are identical to the commands and actions the processor has when communicating with it via RS-232.

By default, Telnet communication on TCP port 23 is disabled on the SSP 200. You can use Telnet by setting the port using Dataviewer (see [Connection Options](#) on page 62) with SIS commands (see [Set Telnet port map](#) on page 71).

LAN port defaults:

DHCP:	off
SSP 200 IP address:	192.168.254.254
Subnet mask:	255.255.0.0
Gateway IP address:	0.0.0.0

Ethernet Connection

The Ethernet cable can be terminated as a straight-through cable or a crossover cable and must be properly terminated for your application (see [figure 7](#) on page 8 for the Ethernet connector pin assignment).

- **Crossover cable** — Direct connection between the computer and the SSP.
- **Patch (straight) cable** — Connection of the SSP to an Ethernet LAN.

Establish a network connection to a SSP 200 processor via an SSH client:

1. Download the SSH client software.
2. Open the SSH software.
3. Enter the IP address of the SSP 200 in the Host Name or IP address field.

NOTE: If the local system administrators have not changed the value, the default IP address is 192.168.254.254.

4. Enter **22023** in the **Port** field.
5. The SSP 200 is password protected, so the appropriate administrator or user name and password must be entered.
 - a. Enter **admin** or **user**.
 - b. Enter the password next to the **Password** prompt).
 - If the login and password are correct, the device responds with a copyright message including the copyright year, the name of the product, firmware version, part number, and the current date and time.
 - If the login and password are incorrect, the login prompt returns. Enter the administrator or user name and password again.

NOTES:

- The SSP 200 is shipped password-protected. The factory configured passwords for all accounts on this device have been set to the device serial number
- In the event of a complete system reset, the passwords convert to the default, which is **extron**. New passwords must be configured to secure the device.

Connection Timeouts

The Ethernet link times out after a designated period of time with no communication. By default, this timeout value is 5 minutes, but the value can be changed.

NOTE: Extron recommends leaving the default timeout at 5 minutes and periodically issuing the Query (Q) command to keep the connection active. If there are long idle periods, disconnect the socket and reopen the connection when another command must be sent.

Verbose Mode

SSH and Telnet connections can be used to monitor for changes that occur, such as SIS commands from other SSH or Telnet sockets or serial port changes. For a session to receive change notices, the session must be in verbose mode 1 or 3 (see **Verbose Mode** on page 74). In verbose mode 1 or 3, the socket reports changes in messages that resemble SIS command responses. Front panel changes are also sent to users who are in verbose mode.

Tagged and Untagged Responses

When a query command is sent in verbose mode 0 or 1, only the “untagged” value is returned. When a query command is sent in other verbose modes, the response is “tagged” and resembles the response to a set command.

Example: The “View Specific Output Channel Trim” command `[Esc]V8SSP←` is sent. The following responses appear depending on the verbose mode:

- **Untagged (verbose 0 or 1):** `-10←`, just the dB value with no other information.
- **Tagged (verbose 2 or 3):** `SspV8*-10←`, the type of query sent, the analog channel queried, and the dB value.

Host-to-device Communications

SIS commands consist of one or more characters per command field. They do not require special characters to begin or end the command sequence. Each response to an SIS command ends with a carriage return and a line feed (CR/LF = `←`), which signals the end of the response character string. A string is one or more characters.

NOTE: Secure Shell (SSH) client connections may add an extra line feed in the final terminator in SIS responses, for example, standard is `[X11]←` and SSH is `[X11]←←`.

Password Information

NOTE: The factory configured passwords for all accounts on this device have been set to the device serial number. In the event of a complete system reset, the passwords convert to the default, which is **extron**.

The `←Password:` prompt requires a password (administrator level or user level) followed by a carriage return. The prompt is repeated if the correct password is not entered.

If the correct password is entered, the unit responds with `←Login Administrator←` or `←Login User←`, depending on the password entered. If passwords are the same for both administrator and user, the unit defaults to administrator privileges.

Error Responses

When the SSP is unable to execute the command, it returns an error response to the host. The error response codes and their descriptions are as follows:

E10 – Unrecognized command	E18 – System timed out
E12 – Invalid port number	E22 – Busy
E13 – Invalid parameter (number is out of range)	E24 – Privilege violation
E14 – Not valid for this configuration	E26 – Maximum connections exceeded
E17 – Invalid command for signal type	E28 – Bad file name or file not found

Using the Command and Response Tables

The **Command and Response Tables** begins on page 69. Symbols used in the table represent variables in the command and response fields. Command and response examples are shown throughout the table. The SIS commands are not case sensitive. The ASCII to Hex conversion table below is for use with the command and response table.

ASCII to HEX Conversion Table															
Space	20	!	21	“	22	#	23	\$	24	%	25	&	26	‘	27
(28)	29	*	2A	+	2B	,	2C	-	2D	.	2E	/	2F
0	30	1	31	2	32	3	33	4	34	5	35	6	36	7	37
8	38	9	39	:	3A	;	3B	<	3C	=	3D	>	3E	?	3F
@	40	A	41	B	42	C	43	D	44	E	45	F	46	G	47
H	48	I	49	J	4A	K	4B	L	4C	M	4D	N	4E	O	4F
P	50	Q	51	R	52	S	53	T	54	U	55	V	56	W	57
X	58	Y	59	Z	5A	[5B	\	5C]	5D	^	5E	_	5F
`	60	a	61	b	62	c	63	d	64	e	65	f	66	g	67
h	68	i	69	j	6A	k	6B	l	6C	m	6D	n	6E	o	6F
p	70	q	71	r	72	s	73	t	74	u	75	v	76	w	77
x	78	y	79	z	7A	{	7B		7C	}	7D	~	7E	DEL	7F

Figure 62. ASCII to Hex Conversion

NOTE: For commands and examples of computer or device responses used in this guide, the character “0” is the number zero and “O” is the capital letter “o”.

Symbol Definitions

- ↵ = CR/LF (carriage return with line feed) (hex 0D 0A)
- ↵ or | = Soft carriage return (no line feed)
- = Space
- Esc or W = Escape
- X1 = Firmware query
 - 0 = Detailed version information (includes all 2Q, 3Q, and 4Q)
 - 1 = Firmware version
 - 2 = Final stage bootloader
 - 3 = Factory base code version
 - 4 = Updated firmware version
- X4 = IP Timeout: The number of seconds before timeout on IP connections (min=1, max =65000 and default = 30 (300 seconds). If no data is received during the timeout period, the Ethernet connection is closed. Each step = 10 seconds.
- X11 = Baud rate: 300, 600, 1200, 1800, 2400, 3600, 4800, 7200, 9600, 14400, 19200, 28800, 38400, 57600, 115200 (default=9600)
- X12 = Parity: Odd, Even, None, Mark, Space [only use the first letter] (default=N=None)
- X13 = Data bits: 7, 8 (default=8)

- X14** = Stop bits: 1, 2 (default=1)
- X15** = Port type: 0=RS232, 1=RS422, 2=RS485 (default=0=RS232)
- X16** = Flow Control: **H**ardware, **S**oftware, **N**one [only use the first letter] (default=**N**=None).
- X17** = Data Pacing [specified in milliseconds between bytes]: 0000 to 1000 (default=0 ms). For host port(s), this value is ignored – always returns 0.
- X19** = GMT offset value: This represent hours and minutes (hh:mm) offset from Greenwich Mean Time.
- X20** = DHCP status
 - 0 = Off (default)
 - 1 = On
- X21** = Unit name: A text string up to 63 characters drawn from the alphabet (A to Z), digits (0 to 9), and minus sign/hyphen (-).
- X22** = Local date and time format: *MM/DD/YY-HH:MM:SS*
- X23** = IP Address: xxx.xxx.xxx.xxx . Leading zeros in each of the 4 fields are optional in setting values and are suppressed in responses.
- X24** = Hardware MAC address: 00-05-A6-xx-xx-xx
- X25** = Subnet mask: xxx.xxx.xxx.xxx . Leading zeros in each of the 4 fields are optional in setting values and are suppressed in responses.
- X26** = NIC number: Network Interface Card number 1 or 2.
- X27** = Prefix (subnet mask bits): Subnet 255.255.0.0 is represented as a prefix value of /16.
- X28** = Date/Time returned in 7 Hex bytes month, day, year, hour minutes, seconds, day of the week (1 begins on Sunday).
- X29** = NTP service mode
 - 0 = Disable
 - 1 = Enable
- X30** = Default name: Combination of model-name and last 3 pairs of MAC address (for example: SSP-200-00-02-3D).
- X31** = Password: Password: Up to 128 characters. All man-readable characters are permitted except "|". Password cannot be a single space. Passwords are case-sensitive.
- X32** = Responds with 4 asterisks (****) if password exists and empty if not, instead of actual password.
- X33** = Connection security level
 - 11 = User
 - 12 = Administrator
- X37** = Device temperature (degrees Celsius)
- X38** = Verbose/response mode
 - 0 = Clear/none (IP default)
 - 1 = Verbose mode (USB default)
 - 2 = Tagged responses for queries
 - 3 = Verbose mode and tagged responses for queries
- X40** = Serial Host-control port mode:
 - 0 = Device Control (no SIS)
 - 1 = Standard Host control (SIS - default)
 - 2 = Disable Port
- X41** = Connection status
 - 1 = Connected
 - 2 = Not Connected
- X42** = Input number: 1 to 5.
- X43** = EXP assignment (HDMI and analog inputs are unavailable for EXP assignment):
 - 0 = EXP off (default)
 - 2 = Input 2
 - 3 = Input 3
 - 4 = Input 4

- X44** = EXP input channel pair:
- | | |
|---------------------|-----------------------|
| 1 = EXP Input 1 & 2 | 5 = EXP Input 9 & 10 |
| 2 = EXP Input 3 & 4 | 6 = EXP Input 11 & 12 |
| 3 = EXP Input 5 & 6 | 7 = EXP Input 13 & 14 |
| 4 = EXP Input 7 & 8 | 8 = EXP Input 15 & 16 |
- X45** = Source format:
- | | |
|------------------------------|---|
| 0 = Not present | 7 = Dolby TrueHD ATMOS |
| 1 = Analog | 8 = DTS or DTS 96/24 |
| 2 = PCM | 9 = DTS-ES (96/24, Matrix, or Discrete) |
| 3 = Dolby Digital/EX | 10 = DTS-HD High Resolution Audio |
| 4 = Dolby Digital Plus | 11 = DTS-HD Master Audio |
| 5 = Dolby Digital Plus ATMOS | 12 = DTS Express |
| 6 = Dolby TrueHD | 13 = DTS:X |
- X46** = Decoded Sampling Rate
- | | |
|--------------|---------------|
| 0 = None | 4 = 88.2 kHz |
| 1 = 32 kHz | 5 = 96 kHz |
| 2 = 44.1 kHz | 6 = 176.4 kHz |
| 3 = 48 kHz | 7 = 192 kHz |
- X47** = Source Encoded Channels (Front, Center, Surround, Back, Subwoofer, Height)
- | | |
|----------|----------|
| 0 = None | 8 = 4.1 |
| 1 = 1.0 | 9 = 5.0 |
| 2 = 1.1 | 10 = 5.1 |
| 3 = 2.0 | 11 = 6.0 |
| 4 = 2.1 | 12 = 6.1 |
| 5 = 3.0 | 13 = 7.0 |
| 6 = 3.1 | 14 = 7.1 |
| 7 = 4.0 | |
- X48** = Signal Status:
- 0 = Signal not detected
 - 1 = Signal detected
- X49** = Input HDCP status:
- 0 = No source is detected
 - 1 = Source is detected with HDCP
 - 2 = Source detected without HDCP
- X50** = Enable or Disable:
- 0 = Disable
 - 1 = Enable (default)
- X53** = HDMI Loop Out mode:
- 0 = No audio
 - 1 = Follow input
 - 2 = Downmix (Default)
- X54** = Output HDCP status:
- 0 = No sink detected
 - 1 = Sink detected with HDCP
 - 2 = Sink detected without HDCP
- X55** = Output HDCP mode:
- 1 = Auto: Encrypt as required by input. Continuous trials for HDMI sinks (Default)
 - 2 = Always Encrypt Output. Continuous trials for HDMI sinks
- X57** = Output channel (channels 7 to 10 change depending on layout and downmix settings):
- 1 to 10 or 15 to 16.

Output Channels Table

	1 Height Pair (no Downmix)	2 Height Pairs (no Downmix)	0 Height + Downmix	1 Height Pair + Downmix
1	Left front	Left front	Left front	Left front
2	Right Front	Right Front	Right Front	Right Front
3	Center	Center	Center	Center
4	Subwoofer	Subwoofer	Subwoofer	Subwoofer
5	Left Surround	Left Surround	Left Surround	Left Surround
6	Right Surround	Right Surround	Right Surround	Right Surround
7	Left Back	Left Height Front	Left Back	Left Height Front
8	Right Back	Right Height Front	Right Back	Right Height Front
9	Left Height Front	Left Height Back	Downmix L	Downmix L
10	Right Height Front	Right Height Back	Downmix R	Downmix R

- X58** = dB value: -24 to 0 (default 0)
- X60** = Audio Mute: 0 = Mute off (default) 1 = Mute on
- X62** = %: 0 to 100 (default 80)
- X65** = dB value: -18 to +24 (default 0)
- X67** = Executive mode number
 0 = Unlock front panel (default)
 1 = Lock front panel
 2 = Limit front panel to volume control
 3 = Limit front panel to input selection
- X77** = Slot number: 1 = HDMI input 2 = Loop Thru
- X78** = 128 or 256 byte EDID raw HEX (text form) from currently assigned EDID.
- X79** = Native resolution and refresh rate from currently assigned EDID, for example: 1920x1080 @ 60 Hz.
- X81** = Connection status:
 0 = Not connected
 1 = Connected
- X89** = Offset: 0-3000, 10x time value, from 0.0 to 300.0 milliseconds
- X90** = Mono output mode:
 1 = Center channel only (default)
 2 = Front left and right only
- X93** = Subwoofer mode:
 0 = All off
 1 = LFE (SUB) (default)
- X98** = Listening mode:
 1 = Auto (follow source) 5 = Mono to all
 2 = Stereo 6 = Dolby Surround (Upmixer)
 3 = Mono 7 = DTS Neural: X (Upmixer)
 4 = Stereo to all
- X109** = Volume level: 0 to 100 (-100 dB to 0 dB)
- X111** = Analog input gain: -18 to +24 dB
- X112** = Clip status:
 0 = Off (no clipping)
 1 = On (clipping)
- X120** = Text – up to 64 characters
- X121** = SNMP Trap target number (1 to 3)
- X122** = SNMP Trap version for target (2 or 3)

NOTE: Unless otherwise indicated, commands are **not** case-sensitive.

Command and Response Tables

Command	SIS Command (Host to Device)	Response (Device to Host)	Additional Description
Firmware Version/Part Number/Information Queries			
Query model name	1I <i>Verbose modes 2/3</i>	SSP•200← Inf01*SSP•200←	
Query model description	2I <i>Verbose modes 2/3</i>	Surround•sound•processor← Inf02*Surround•sound•processor←	
Query firmware version	Q <i>Verbose modes 2/3</i>	{version x.xx}← Ver01*{version x.xx}←	
Query firmware version (advanced)	X2Q <i>Verbose modes 2/3</i>	{Specific version info}← VerX1*{Specific version info}←	
Query firmware version (w/build)	*Q <i>Verbose modes 2/3</i>	{version x.xx.xxxx}← Bld{version x.xx.xxxx}←	
Query Kernel/Library version	**Q <i>Verbose modes 2/3</i>	{version x.xx.xxxxLX}← Lib{version x.xx.xxxxLX}←	
Query system messaging version	***Q <i>Verbose modes 2/3</i>	{version}← Idv{version x.xx}←	
Query part number	N <i>Verbose modes 2/3</i>	zz-zzzz-zz← Pnozz-zzzz-zz←	
KEY: X1 = Firmware query 0 = Detailed version information (includes all 2Q, 3Q, and 4Q) 1 = Firmware version 2 = Final Stage bootloader version 3 = Factory Base Code version 4 = Updated Firmware version			
Ethernet Data Port			
Set current connector port timeout	Esc0*X4TC←	Pti0*X4←	
View current connector port timeout	Esc0TC←	X4←	
Set global IP port timeout	Esc1*X4TC←	Pti1*X4←	
View global IP port timeout	Esc1TC←	X4←	
KEY: X4 = IP Timeout: The number of seconds before timeout on IP connections (min=1, max =65000 and default = 30 (300 seconds)). If no data is received during the timeout period, the Ethernet connection is closed. Each step = 10 seconds.			
Serial Data Port (including Device control and Host control ports)			
Configure parameters	Esc1*X11X12X13X14CP←	Cpn1•CcpX11X12X13X14←	
View parameters	Esc1CP←	X11X12X13X14←	
Configure mode	Esc1*X15CY←	Cpn1•CtyX15←	
View mode	Esc1CY←	X15←	
Configure flow control	Esc1*X16X17CF←	Cpn1•CflX16X17←	
View flow control	Esc1CF←	X16X17←	
KEY: X11 = Baud rate: 300, 600, 1200, 1800, 2400, 3600, 4800, 7200, 9600, 14400, 19200, 28800, 38400, 57600, 115200 (default=9600) X12 = Parity: O dd, E ven, N one, M ark, S pace [only use the first letter] (default=N=None) X13 = Data bits: 7, 8 (default=8) X14 = Stop bits: 1, 2 (default=1) X15 = Port type: 0=RS232 1=RS422 2=RS485 (default=0=RS232) X16 = Flow Control: H ardware, S oftware, N one [only use the first letter] (default=N=None) X17 = Data Pacing [specified in milliseconds between bytes]: 0000 – 1000 (default=0 ms). For host port(s), this value is ignored – always returns 0.			

Command	SIS Command (Host to Device)	Response (Device to Host)	Additional Description
IP Setup Commands			
Set Unit name	Esc X21 CN←	Ipn• X21 ←	
Set Unit name to factory default	Esc •CN←	Ipn• X30 ←	
View Unit name	Esc CN←	X21 ←	
Set date/time	Esc X22 CT←	Ipt• X22 ←	
View date/time	Esc CT←	X22 ←	
View date/time in Hex	Esc *CT←	X28 ←	
View GMT offset	Esc CZ← <i>Verbose modes 2/3</i>	X19 ← Ipz X19 ←	
Set DHCP on	Esc 1DH←	Idh1←	
Set DHCP off	Esc 0DH←	Idh0←	
View DHCP mode	Esc DH←	X20 ←	
Set IP address	Esc X23 CI←	Ipi• X23 ←	
View IP address	Esc CI←	X23 ←	
View hardware address (MAC)	Esc CH← <i>Verbose modes 2/3</i>	X24 ← Iph• X24 ←	
Set subnet mask	Esc X25 CS←	Ips• X25 ←	
View subnet mask	Esc CS←	X25 ←	
Set gateway IP address	Esc X23 CG←	Ipg• X23 ←	
View gateway IP address	Esc CG←	X23 ←	
Set IP	Esc 1* X23 CISG←	Cisg•1* X23 / X27 * X23 ←	
Set IP/Subnet	Esc 1* X23 * X25 CISG←	Cisg•1* X23 / X27 * X23 ←	
Set IP/Subnet/Gateway	Esc 1* X23 * X25 * X23 CISG←	Cisg•1* X23 / X27 * X23 ←	
View IP/Subnet/Gateway (all)	Esc 1CISG← <i>Verbose modes 2/3</i>	X23 / X27 * X23 ←	
Set DNS Server IP address	Esc X23 DI←	Ipd• X23 ←	
View DNS Server IP address	Esc DI← <i>Verbose modes 2/3</i>	X23 ←	
View connection listing	Esc CC← <i>Verbose modes 2/3</i>	{ <i>Number of connections</i> }← Icc{ <i>Number of connections</i> }←	
View device info	Esc BC←	<part number>null<firmware ver>null<box name>null <6-byte MAC address in binary>	

KEY: **X19** = GMT offset value: This represent hours and minutes (hh:mm) offset from Greenwich Mean Time (GMT).
X20 = DHCP status: 0 = Off (default) 1 = On
X21 = Unit name: A text string up to 63 characters drawn from the alphabet (A-Z), digits (0-9), and minus sign/hyphen (-).
X22 = Local date and time format: MM/DD/YY-HH:MM:SS
X23 = IP Address: xxx.xxx.xxx.xxx . Leading zeros in each of the 4 fields are optional in setting values and are suppressed in responses.
X24 = Hardware MAC address: 00-05-A6-xx-xx-xx
X25 = Subnet mask: xxx.xxx.xxx.xxx. Leading zeros in each of the 4 fields are optional in setting values and are suppressed in responses.
X27 = Prefix (subnet mask bits): Subnet 255.255.0.0 is represented as a prefix value of /16.
X28 = Date/Time returned in 7 Hex bytes month, day, year, hour minutes, seconds, day of the week (1 begins on Sunday).
X30 = Default name: Combination of model-name and last 3 pairs of MAC address (for example: SSP-200-01-23-4D).

Command	SIS Command (Host to Device)	Response (Device to Host)	Additional Description
Network Time Protocol (NTP)			
Enable NTP to set the time	Esc 1NTEN←	Nten1←	
Disable NTP	Esc 0NTEN←	Nten0←	
Sync NTP now	Esc 2NTEN←	Nten2←	
View NTP status	Esc NTEN←	X29 ←	
Set NTP IP address	Esc X23 NTIP←	Ntip X23 ←	
Set NTP IP address to default	Esc •NTIP←	Ntip←	
View NTP IP address	Esc NTIP←	X23 ←	
Set NTP port map	Esc N{port#}PMAP←	PmapN{port#}←	
Reset NTP port map	Esc N123PMAP←	PmapN00123←	
Disable NTP port	Esc N0PMAP←	PmapN00000←	
View NTP port map	Esc NPMAP←	{port#}←	
KEY: X23 = IP Address: xxx.xxx.xxx.xxx . Leading zeros in each of the 4 fields are optional in setting values and are suppressed in responses. X29 = NTP service mode: 0 = Disable 1 = Enable			
Port Assignment			
Set Telnet port map	Esc {port#}MT←	Pmt{port#}←	
Reset Telnet port map	Esc 23MT←	Pmt00023←	
Disable Telnet port	Esc 0MT←	Pmt00000←	
View Telnet port map	Esc MT←	{port#}←	
Set Web port map	Esc {port#}MH←	Pmh{port#}←	
Reset Web port map	Esc 80MH←	Pmh00080←	
Disable Web port	Esc 0MH←	Pmh00000←	
View Web port map	Esc MH←	{port#}←	
Set SNMP port map	Esc A{port#}PMAP←	PmapA{port#}←	
Reset SNMP port map	Esc A161PMAP←	PmapA00161←	
Disable SNMP port	Esc A0PMAP←	PmapA00000←	
View SNMP port map	Esc APMAP←	{port#}←	
Set SSH port map	Esc B{port#}PMAP←	PmapB{port#}←	
Reset SSH port map	Esc B22023PMAP←	PmapB22023←	
Disable SSH port	Esc B0PMAP←	PmapB00000←	
View SSH port map	Esc BPMAP←	{port#}←	
Set SSL port map	Esc S{port#}PMAP←	PmapS{port#}←	
Reset SSL port map	Esc S443PMAP←	PmapS00443←	
Disable SSL port	Esc S0PMAP←	PmapS00000←	
View SSL port map	Esc SPMAP←	{port#}←	
Set FTP port map	Esc F{port#}PMAP←	PmapF{port#}←	
Reset FTP port map	Esc F21PMAP←	PmapF00021←	

Command	SIS Command (Host to Device)	Response (Device to Host)	Additional Description
Port Assignment (continued)			
Disable FTP port	Esc F0PMAP ←	PmapF00000 ←	
View FTP port map	Esc FPMAP ←	{port#} ←	
Set TFTP port map	Esc T{port#}PMAP ←	PmapT{port#} ←	
Reset TFTP port map	Esc T69PMAP ←	PmapT00069 ←	
Disable TFTP port	Esc T0PMAP ←	PmapT00000 ←	
View TFTP port map	Esc TPMAP ←	{port#} ←	
Simple Network Management Protocol (SNMP)			
Set unit contact	Esc C[X120]SNMP ←	SnmpC*[X120] ←	
Set unit contact to default	Esc C•SNMP ←	SnmpC*Not•Specified ←	
View unit contact	Esc CSNMP ←	[X120] ←	
Set unit location	Esc L[X120]SNMP ←	SnmpL*[X120] ←	
Set unit location to default	Esc L•SNMP ←	SnmpL*Not•Specified ←	
View unit location	Esc LSNMP ←	[X120] ←	
Set community public (read-only)	Esc P[X120]SNMP ←	SnmpP*[X120] ←	
Set community public to default	Esc P•SNMP ←	SnmpP*public ←	
View community public	Esc PSNMP ←	[X120] ←	
Set community private (read/write)	Esc X[X120]SNMP ←	SnmpX*[X120] ←	
Set community private to default	Esc SnmpX*[X120] ←	SnmpX*private ←	
View community private	Esc XSNMP ←	[X120] ←	
Enable SNMP access and traps	Esc E1SNMP ←	SnmpE*1 ←	
Disable SNMP access and traps	Esc E0SNMP ←	SnmpE*0 ←	
View SNMP access setting	Esc ESNMP ←	[X29] ←	
Set trap target	Esc T[X120],[X121]*[X23]*[X122]SNMP ←	SnmpT*[X120],[X121]*[X23]*[X122] ←	
Remove trap target	Esc T[X121]*0SNMP ←	SnmpT*,[X121]*0.0.0.0*0 ←	
View trap target	Esc T[X121]SNMP ←	[X120],[X23]*[X122] ←	
KEY: [X23] = IP Address: xxx.xxx.xxx.xxx . Leading zeros in each of the 4 fields are optional in setting values and are suppressed in responses. [X29] = NTP service mode: 0 = Disable 1 = Enable [X120] = Text – up to 64 characters [X121] = SNMP Trap target number (1 to 3) [X122] = SNMP Trap version for target (2 or 3)			

Command	SIS Command (Host to Device)	Response (Device to Host)	Additional Description
Password and Security Settings			
Set admin password	Esc X31 CA←	Ipa• X32 ↵	
Clear admin password	Esc •CA←	Ipa•↵	
View admin password	Esc CA←	X32 ↵	
Set user password	Esc X31 CU←	Ipu• X32 ↵	
Clear user password	Esc •CU←	Ipu•↵	
View user password	Esc CU←	X32 ↵	
Query session security level	Esc CK← <i>Verbose modes 2/3</i>	X33 ↵ Pv1 X33 ↵	
<p>KEY: X31 = Password: Up to 128 characters. All man-readable characters are permitted except " ". Password cannot be a single space. Passwords are case-sensitive. The factory configured password for this device is set to the device serial number. When performing a factory reset, the password is set to the default password, which is extron.</p> <p>X32 = Responds with 4 asterisks (****) if password exists and empty if not, instead of actual password.</p> <p>X33 = Connection security level: 11 = User 12 = Administrator</p>			
Directories			
Change/create directory	Esc path/directory/CJ←	Dir•path/directory/↵	
Back to root directory	Esc /CJ←	Dir•/↵	
Up one directory	Esc ..CJ←	Dir•path/directory/↵	
View current directory	Esc CJ←	path/directory/↵	
File Commands			
Erase user-supplied web page/file	Esc fiLenamEF←	Del1fiLenam↵	
Erase current directory and contained files	Esc /EF←	Dd1↵	
Erase current directory and subdirectories	Esc //EF←	Dd1↵	
List files from current directory	Esc DF←	fiLenam•date/time•Length↵	
Load file to user flash memory	Esc +UFfiLenam,fiLenam←	Up1↵	
Retrieve file from user flash memory	Esc fiLenamSF←	{responds with 4-bytes of file-size + raw unprocessed data in file}	
Backup/Restore Box Configuration			
Save box configuration (to filesystem)	Esc 1*{config type}XF←	Cfg1*{config type}↵	
Restore box configuration	Esc 0*{config type}XF←	Cfg0*{config type}↵	

Command	SIS Command (Host to Device)	Response (Device to Host)	Additional Description
Miscellaneous			
Reboot system	Esc 1B00T←	Boot1↵	
Reboot network	Esc 2B00T←	Boot2↵	
View temperature	Esc 20STAT←	X37 ↵	
KEY: X37 = Device temperature (degrees Celsius).			
Verbose Mode			
Set verbose mode	Esc X38 CV←	Vrb X38 ↵	
View verbose mode	Esc CV←	X38 ↵	
NOTE: Verbose mode reverts back to default in the event of a power cycle, disconnect from SSH client, or disconnect from the Ethernet.			
KEY: X38 = Verbose/response mode: 0 = Clear/none (IP default) 1 = Verbose mode (USB default) 2 = Tagged responses for queries 3 = Verbose mode and tagged responses for queries			
SIS over SSH (port 22023)			
Enable Echo	Esc 1ECHO←	Echo1↵	Returns command entered with response.
Disable Echo	Esc 0ECHO←	Echo0↵	Returns response only.
View Echo status	Esc ECHO←	X50 ↵	
NOTE: Secure Shell (SSH) client connections may add an extra line feed in the final terminator in SIS responses, for example, standard is X11 ↵↵ and SSH is X11 ↵↵↵			
KEY: X50 = Enable or disable: 0 = Disable 1 = Enable (default)			
Serial Host Control Port Mode			
Standard Host control (SIS)	Esc 1*1HSTM←	Hstm X40 *1↵	
Device control (no SIS)	Esc 1*2HSTM←	Hstm X40 *2↵	
Disable port	Esc 1*0HSTM←	Hstm X40 *0↵	
Query port mode	Esc 1HSTM←	X40 ↵	
KEY: X40 = Serial Host-control port mode: 0 = Device Control (no SIS) 1 = Standard Host control (SIS - default) 2 = Disable Port			

Command	SIS Command (Host to Device)	Response (Device to Host)	Additional Description
Input Selection			
Select audio input	X42 \$	Aud X42 ↵	
View audio input	\$ <i>Verbose modes 2/3</i>	X42 ↵ Aud X42 ↵	
Set EXP input assignment	Esc E X43 SSP↵	SspE X43 ↵	
View EXP input assignment	Esc ESSP↵ <i>Verbose modes 2/3</i>	X43 ↵ SspE X43 ↵	
Set EXP input channel pair	Esc P X44 SSP↵	SspP X44 ↵	
View EXP input channel pair	Esc PSSP↵ <i>Verbose modes 2/3</i>	X44 ↵ SspP X44 ↵	
View audio input source	33I <i>Verbose modes 2/3</i>	SrcFormat• X45 •Sampling• X46 •EnChan• X47 ↵ Inf33SrcFormat• X45 •Sampling• X46 •EnChan• X47 ↵	
View audio signal presence (selected input)	Esc 0LS↵ <i>Verbose modes 2/3</i>	X48 ↵ In00• X48 ↵	
View input HDCP status	Esc IHDCP↵ <i>Verbose modes 2/3</i>	X49 ↵ Hdcp1 X49 ↵	
Set HDCP authorization	Esc E X50 HDCP↵	HdcpE X50 ↵	
View HDCP authorization status	Esc EHDCP↵ <i>Verbose modes 2/3</i>	X50 ↵ HdcpE X50 ↵	
View incoming line count	34I <i>Verbose modes 2/3</i> Example:	<Total Lines>*<Vfreq>*<Hfreq>*<Hcount>↵ Inf34*<Total Lines>*<Vfreq>*<Hfreq>*<Hcount>↵ Inf34*1080*60.016788*67.498636*1920↵	
KEY:			
X42 = Input number: 1 to 5			
X43 = EXP assignment (HDMI and analog inputs are unavailable for EXP assignment): 0 = EXP off (default) 2 = Input 2 3 = Input 3 4 = Input 4			
X44 = EXP input channel pair: 1 = EXP Input 1 & 2 2 = EXP Input 3 & 4 3 = EXP Input 5 & 6 4 = EXP Input 7 & 8 5 = EXP Input 9 & 10 6 = EXP Input 11 & 12 7 = EXP Input 13 & 14 8 = EXP Input 15 & 16			
X45 = Source format: 0 = Not present 1 = Analog 2 = PCM 3 = Dolby Digital/EX 4 = Dolby Digital Plus 5 = Dolby Digital Plus ATMOS 6 = Dolby TrueHD 7 = Dolby TrueHD ATMOS 8 = DTS or DTS 96/24 9 = DTS-ES (96/24, Matrix, or Discrete) 10 = DTS-HD High Resolution Audio 11 = DTS-HD Master Audio 12 = DTS Express 13 = DTS:X			
X46 = Decoded Sampling Rate: 0 = None 1 = 32 kHz 2 = 44.1 kHz 3 = 48 kHz 4 = 88.2 kHz 5 = 96 kHz 6 = 176.4 kHz 7 = 192 kHz			
X47 = Source Encoded Channels (Front, Center, Surround, Back, Subwoofer, Height): 0 = None 1 = 1.0 2 = 1.1 3 = 2.0 4 = 2.1 5 = 3.0 6 = 3.1 7 = 4.0 8 = 4.1 9 = 5.0 10 = 5.1 11 = 6.0 12 = 6.1 13 = 7.0 14 = 7.1			
X48 = Signal Status: 0 = Signal not detected 1 = Signal detected			
X49 = Input HDCP status: 0 = No source is detected 1 = Source is detected with HDCP 2 = Source detected without HDCP			
X50 = Enable or Disable: 0 = Disable 1 = Enable (default)			

Command	SIS Command (Host to Device)	Response (Device to Host)	Additional Description
Outputs			
Set HDMI Loop Thru	Esc X53 LOUT ←	Lout X53 ↵	
View HDMI Loop Thru	Esc LOUT ← <i>Verbose modes 2/3</i>	X53 ↵ Lout X53 ↵	
View Output HDCP Status	Esc OHDCP ← <i>Verbose modes 2/3</i>	X54 ↵ Hdcp X54 ↵	
Set Output HDCP Mode	Esc S X55 HDCP ←	HdcpS X55 ↵	
View Output HDCP Mode	Esc SHDCP ← <i>Verbose modes 2/3</i>	X55 ↵ HdcpS X55 ↵	
KEY: X53 = HDMI Loop Out mode: 0 = No audio 1 = Follow input 2 = Downmix (Default) X54 = Output HDCP status: 0 = No sink detected 1 = Sink detected with HDCP 2 = Sink detected without HDCP X55 = Output HDCP mode: 1 = Auto: encrypt as required by input. Continuous trials for HDMI sinks. (Default) 2 = Always Encrypt Output: Continuous trials for HDMI sinks			
Level Control			
Output Channel Trim Settings			
Set specific output channel trim	Esc V X57 * X58 SSP ←	SspV X57 * X58 ↵	
View specific output channel trim	Esc V X57 SSP ← <i>Verbose modes 2/3</i>	X58 ↵ SspV X57 * X58 ↵	
KEY: X57 = Analog output channel (channels 7–10 change depending on layout and downmix settings): 1 to 10 or 15 to 16 (see Output Channels Table on page 68 for details). X58 = dB value: -24 to 0 (default 0)			
Audio Mute			
Mute all output channels (global mute)	1Z	Amt X60 ↵	Sets mute to on for all channels.
Unmute all output channels (global unmute)	0Z	Amt X60 ↵	Sets mute to off for all channels.
View global mute status	Z	X60 ↵	Returns 1 when all outputs are muted. Returns 0 if any outputs are unmuted.
Mute specific channel	X57 *1Z	Amt X57 * X60 ↵	Sets mute to on for selected channel.
Unmute specific channel	X57 *0Z	Amt X57 * X60 ↵	Sets mute to off for selected channel.
View mute of specific channel	X57 *Z	X60 ↵	Shows the mute status of the selected channel.
KEY: X57 = Analog output channel (channels 7–10 change depending on layout and downmix settings): 1 to 12 or 15 to 16 (see Output Channels Table on page 68 for details). X60 = Audio Mute: 0 = Mute off (default) 1 = Mute on			

Command	SIS Command (Host to Device)	Response (Device to Host)	Additional Description
Volume			
Specify volume	X62 V	Vol X62 ↵	
Increment volume (+)	+V	Vol X62 ↵	
Decrement volume (-)	-V	Vol X62 ↵	
View volume setting	V <i>Verbose modes 2/3</i>	X62 ↵ Vol X62 ↵	
KEY: X62 = %: 0 to 100 (default 80)			
Analog Input Level			
Set analog input gain level (input 5 only)	Esc A X65 SSP↵	SspA X65 ↵	
View analog input gain level (input 5 only)	Esc ASSP↵ <i>Verbose modes 2/3</i>	X65 ↵ SspA X65 ↵	
View clip status	3S <i>Verbose modes 2/3</i>	X112 ↵ Sts3* X112 ↵	
KEY: X65 = dB value: -18 to +24 (default 0) X112 = Clip status: 0 = Off (no clipping) 1 = On (clipping)			
Executive Modes			
Set Executive Mode	X67 X	Exe X67 ↵	
View Executive Mode	X <i>Verbose modes 2/3</i>	X67 ↵ Exe X67 ↵	
KEY: X67 = Executive mode number 0 = Unlock front panel (default) 1 = Lock front panel 2 = Limit front panel to volume control 3 = Limit front panel to input selection.			
EDID Minder			
Import EDID (.bin) to input (store) slot	Esc I X77 ,<filename>EDID↵	EdidI X78 ↵	Import EDID from <filename> to input slot x77
Export EDID (.bin) to PC	Esc E X77 ,<filename>EDID↵	EdidE X78 ↵	Export EDID from EDID table slot x77 to <filename>
View EDID in HEX format	Esc REDID↵ <i>Verbose modes 2/3</i>	X78 ↵ EdidR X78 ↵	EDID record: 128 or 256 Bytes (delivered as Hex)
View EDID native resolution	Esc NEDID↵ <i>Verbose modes 2/3</i>	X79 ↵ EdidN X79 ↵	View native resolution & refresh rate of EDID from EDID table slot 1. Example: 1920x1080 @60.00Hz
KEY: X77 = Slot number: 1 = HDMI input 2 = Loop Thru X78 = 128 or 256 byte EDID raw HEX (text form) from currently assigned EDID X79 = Native resolution and refresh rate from currently assigned EDID, for example: 1920x1080 @60 Hz.			
EXP Port			
Get current device connection status	Esc REXP↵ <i>Verbose modes 2/3</i>	X81 ↵ ExpR X81 ↵	
KEY: X81 = Connection status: 0 = Not connected 1 = Connected			

Command	SIS Command (Host to Device)	Response (Device to Host)	Additional Description
Layouts and Speakers			
Set lip-sync offset	[Esc]Y[X42]*[X89]SSP ←	SspY[X42]*[X89]↵	
View lip-sync offset	[Esc]Y[X42]SSP ← <i>Verbose modes 2/3</i>	[X89]↵ SspY[X42]*[X89]↵	
Set mono output mode	[Esc]M[X90]SSP ←	SspM[X90]↵	
View mono output mode	[Esc]MSSP ← <i>Verbose modes 2/3</i>	[X90]↵ SspM[X90]↵	
KEY: [X42] = Input number: 1 to 5 [X89] = Offset: 0 to 3000, 10x time value, from 0.0 to 300.0 milliseconds [X90] = Mono output mode: 1 = Center channel only (default) 2 = Front left and right only			
Subwoofer			
Set subwoofer mode	[Esc]J[X93]SSP ←	SspJ[X93]↵	
View subwoofer mode	[Esc]JSSP ← <i>Verbose modes 2/3</i>	[X93]↵ SspJ[X93]↵	
KEY: [X93] = Subwoofer mode: 0 = Off 1 = LFE (SUB) (default).			
Surround			
View listening mode	[Esc]L[X42]*[X45]SSP ← <i>Verbose modes 2/3</i>	[X98]↵ SspL[X42]*[X45]*[X98]↵	
KEY: [X42] = Input number: 1 to 5 [X45] = Source format: 0 = Not present 1 = Analog 2 = PCM 3 = Dolby Digital 4 = Dolby Digital Plus 5 = Dolby Digital Plus ATMOS 6 = Dolby TrueHD 7 = Dolby TrueHD ATMOS 8 = DTS or DTS 96/24 9 = DTS-ES (96/24, Matrix, or Discrete) 10 = DTS-HD High Resolution Audio 11 = DTS-HD Master Audio 12 = DTS Express 13 = DTS:X [X98] = Listening mode: 1 = Auto (follow source) 2 = Stereo 3 = Mono 4 = Stereo to all 5 = Mono to all 6 = Dolby Surround (Upmixer) 7 = DTS Neural: X (Upmixer)			
Resets			
System reset (factory default)	[Esc]ZXXX ←	Zpx↵	
Absolute reset including IP settings	[Esc]ZQQQ ←	Zpq↵	

Description	Response (Device to Host)
Unsolicited Responses	
Audio Input	Aud[X42]←↵
Audio input source change	Inf33SrcFormat•[X45]•Sampling•[X46]•EnChan•[X47]←↵
Volume level	Vol[X109]←↵
Input listening mode	Sspl[X42]*[X98]←↵
Analog level adjustment	SspA[X111]←↵
Analog input clip status	Sts3*[X112]←↵
Current device EXP connection status	ExpR[X41]←↵
EXP input assignment	SspE[X43]←↵
<p>KEY: [X41] = Connection Status: 1 = Connected 2 = Not Connected.</p> <p>[X42] = Input number: 1 to 5.</p> <p>[X43] = EXP assignment (HDMI and analog inputs are unavailable for EXP assignment): 0 = EXP off (default) 2 = Input 2 3 = Input 3 4 = Input 4.</p> <p>[X45] = Source format: 0 = Not present 1 = Analog 2 = PCM 3 = Dolby Digital 4 = Dolby Digital Plus 5 = Dolby Digital Plus ATMOS 6 = Dolby TrueHD 7 = Dolby TrueHD ATMOS 8 = DTS or DTS 96/24 9 = DTS-ES (96/24, Matrix, or Discrete) 10 = DTS-HD High Resolution Audio 11 = DTS-HD Master Audio 12 = DTS Express 13 = DTS:X</p> <p>[X46] = Decoded Sampling Rate: 0 = None 1 = 32 kHz 2 = 44.1 kHz 3 = 48 kHz 4 = 88.2 kHz 5 = 96 kHz 6 = 176.4 kHz 7 = 192 kHz</p> <p>[X47] = Source Encoded Channels (Front, Center, Surround, Back, Subwoofer, Height): 0 = None 1 = 1.0 2 = 1.1 3 = 2.0 4 = 2.1 5 = 3.0 6 = 3.1 7 = 4.0 8 = 4.1 9 = 5.0 10 = 5.1 11 = 6.0 12 = 6.1 13 = 7.0 14 = 7.1</p> <p>[X98] = Listening mode: 1 = Auto (follow source) 2 = Stereo 3 = Mono 4 = Stereo to all 5 = Mono to all 6 = Dolby Surround (Upmixer) 7 = DTS Neural: X (Upmixer)</p> <p>[X109] = Volume level: 0 to 100 (0% to 100%)</p> <p>[X111] = Analog input gain: -18 to +24 dB</p> <p>[X112] = Clip status: 0 = Off (no clipping) 1 = On (clipping)</p>	

Internal Web Page

This section gives an overview of the SSP 200 internal web page. Topics include:

- [Overview of the Internal Web Page](#)
- [Accessing the Internal Web Page](#)
- [Web Page Components](#)

Overview of the Internal Web Page

The SSP 200 internal web pages provide the software user interface for operating and configuring the SSP 200 via a PC on the same network. This allows you to:

- View and edit the device name
- Set the date and time either manually or to sync with a connected PC
- View input and output details
- View and edit the network settings
- Update the firmware version

Connection is made via a LAN or WAN connection through the rear panel LAN (RJ-45) port, using a web browser such as Microsoft® Edge®, Mozilla® Firefox®, Google Chrome™, or Apple® Safari®.

Accessing the Internal Web Page

To access the internal web pages:

1. Using an RJ-45 cable, connect the device to a LAN via the rear panel LAN port (see [Rear Panel Features](#) on page 6).
2. Launch the web browser on your computer.
3. Enter the device IP address into a web browser address bar. If the IP address has not been changed, the default address is **192.168.254.254**.
4. Press the keyboard **<Enter>** key. The SSP 200 web page requires user authentication to continue. Click in the **Password** field and enter the appropriate administrator or user password. Click **OK**.

NOTE: The factory configured passwords for all accounts on this device have been set to the device serial number. Passwords are case sensitive. If the SSP 200 is reset, the passwords revert to the default, which is **extron**.

Web Page Components

The SSP 200 web page (see figure 63) has eight panels:

- 1 Device Info
- 2 Device Status
- 3 Network Settings
- 4 Inputs
- 5 Outputs
- 6 RS-232
- 7 Roles and Permissions
- 8 Firmware

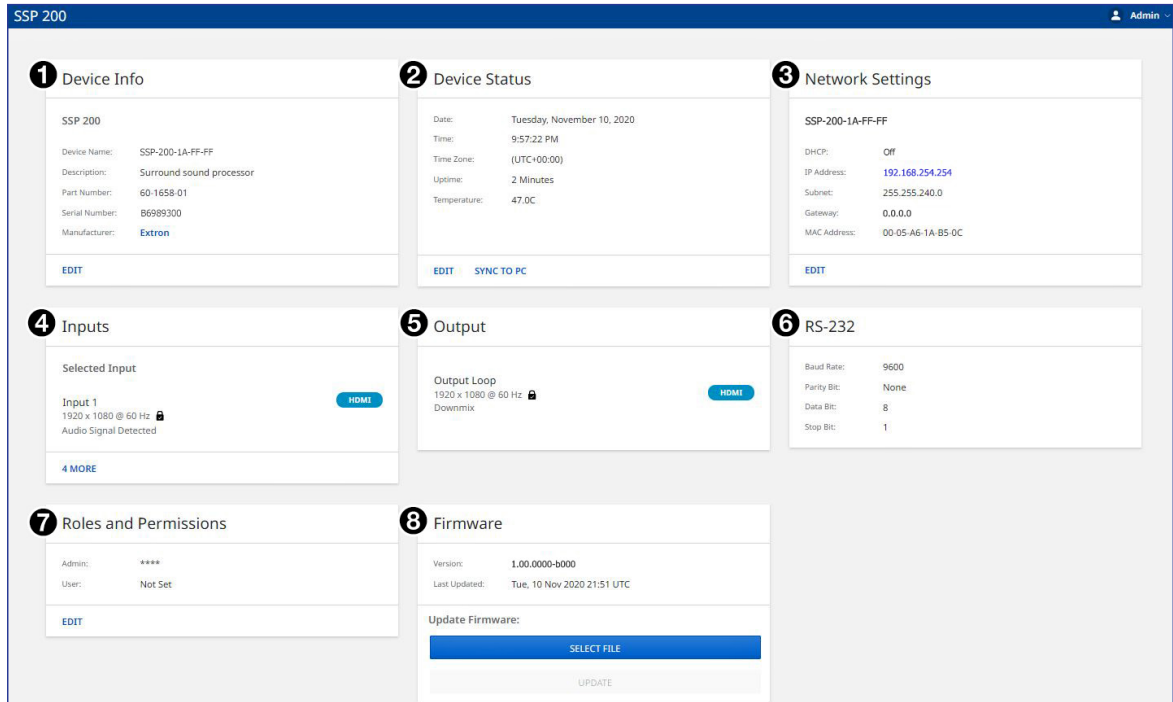

Figure 63. Web Page

Device Info

The Device Info panel shows the current device name, description, part number, and manufacturer. You can change the device name by first clicking **EDIT** (1) on the bottom of the Device Info panel.

This opens the Device Info Settings dialog box (see figure 64).

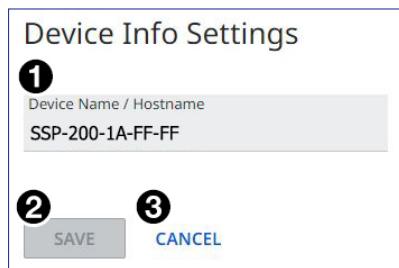

Figure 64. Device Info Settings Dialog Box

To change the device name:

1. Click into the **Device Name** field (see [figure 64](#), **1**, on the previous page).
2. Enter a desired name.

NOTE: The name can have alphanumeric characters and hyphens only. A hyphen cannot be the first or last character. An incorrect name is ignored and the current name is not changed.

3. Click **SAVE** (**2**). The new name is applied, the dialog box closes, and the device name in the **Network Settings** panel is also updated with the new name.

Click **CANCEL** (**3**) to exit the process without making any changes.

NOTE: The default name is a combination of the model name and last three pairs of the MAC address (for example, **SSP-200-18-FF-FF**).

Device Status

The **Device Status** panel (see [figure 64](#), **2**, on the previous page) displays the date, time, and time zone for the connected SSP 200, and allows the user to either synchronize the date and time to a connected PC or set the date and time manually.

To synchronize to the connected PC:

1. On the **Device Status** panel, click **SYNC TO PC**.
2. If successful, you see a confirmation message and the current **Date**, **Time**, and **Timezone** on the **Device Status** panel.

To set the information manually:

1. Click **EDIT** on the **Device Status** panel.

The **Device Status Settings** dialog box appears (see [figure 65](#)).

2. Change **Date and Time** (**1**) and the **Timezone** (**2**) as appropriate.
3. Click **SAVE** (**3**) when done. You see the changes on the **Device Status** panel if the update has been successful.

Click **CANCEL** (**4**) to exit the process without making any changes.

Device Status Settings

1
Date | Time
11/20/19 09:31 PM

2
Timezone
(UTC-08:00/UTC-07:00) Pacific Time

3 **4**
SAVE CANCEL

Figure 65. Device Status Settings

Network Settings

The **Network Settings** panel shows the current network settings for the SSP 200 (see [figure 63](#) on page 81). To change the settings, click **EDIT** to access the **Network Settings** dialog box (see figure 66).

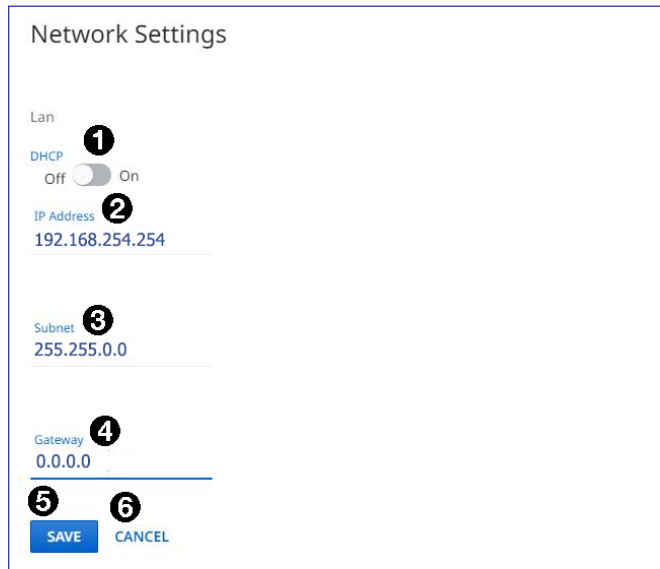

Figure 66. Network Settings Dialog Box

To configure the settings for use with DHCP:

1. Set the DHCP slider (1) to **On**.
2. Click **SAVE** (5). An IP address is automatically assigned to the device. Contact your IT administrator for more information.
Click **CANCEL** (6) to exit the process without making any changes.

To configure the settings with a static IP address:

1. Ensure the DHCP slider (1) is set to **Off**.
1. In the **IP Address** field (2), enter an IP address for the device.
2. In the **Subnet** field (3), enter the subnet mask for the device.
3. In the **Gateway** field (4), enter the default gateway to be used.
4. Click **SAVE** (5) to apply the changes, or click **CANCEL** (6) to exit the process without making any changes.



NOTE: The default TCP/IP settings are:

- IP address = 192.168.254.254
- Subnet Mask = 255.255.0.0
- Default Gateway = 0.0.0.0

Inputs

The **Inputs** panel displays the name and signal type of the active input as well as its HDCP status (see [figure 63](#), [4](#), on page 81).

The following HDCP status indicators may be displayed for a connected input:

Symbol	Definition
	The signal is HDCP encrypted.
	The signal is not encrypted.
No Signal	There is no signal detected.

Click **4 MORE** to see the full **Inputs** panel showing the remaining inputs (see [figure 67](#)). This panel is not user-configurable. Click the **X** on the top right of the panel to return to the main web page.

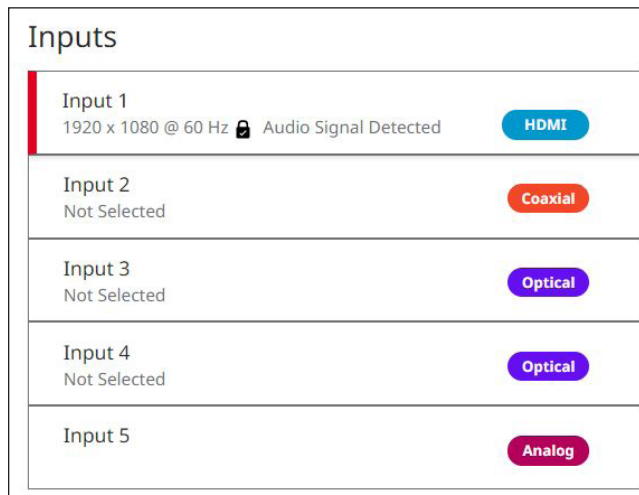



Figure 67. Inputs Panel

NOTE: Input audio format details are only available when an input is selected.

Outputs

This panel displays the status of the connected output (see [figure 63](#), [5](#)). This panel is not user-configurable.

The following status symbols may be displayed for the connected output:

Symbol	Definition
	The signal is HDCP compliant.
	The signal is not compliant.
No Signal	No display is connected.

RS-232

This panel displays RS-232 information (see [figure 63, 6](#), on page 81). This panel is not user-configurable.

Roles and Permissions

The **Roles and Permissions** panel on the main web page gives the user access to set the admin and user passwords for the SSP 200 (see [figure 63, 7](#)).

To change them, click **EDIT** in this panel. The **Roles and Permission Settings** dialog box opens (see figure 68).

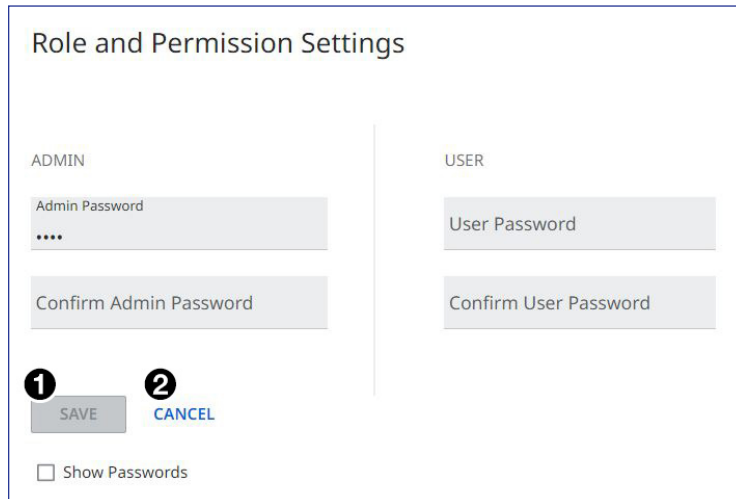

Figure 68. Role and Permission Settings

Change each password field as applicable. Click **SAVE** (1) to apply the changes or **CANCEL** (2) to exit the process without making any changes.

NOTE: The factory configured passwords for all accounts on this device have been set to the device serial number. Passwords are case sensitive. If the SSP 200 is reset, the passwords revert to the default, which is **extron**.

The maximum length of a password is **128** characters. All human-readable characters are permitted except "|". Passwords are case-sensitive and cannot be a single space.

NOTES:

- Only an administrator can set the **admin** password.
- The default admin name is **admin** and the default user name is **user**.
- An indicator of the current login status is shown on the top right corner of the main screen.



Firmware

The **Firmware** panel (see [figure 63](#), **8**, on page 81) displays the current firmware version and when it was last updated to the device (see [figure 69](#), **1**).

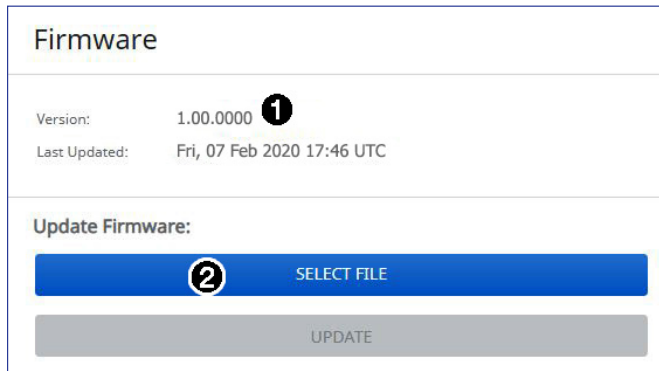

Figure 69. Firmware Panel

NOTE: The latest firmware can be downloaded from the Extron [website](#) (see [Downloading the SSP 200 Firmware](#) on page 58).

To update the SSP 200 firmware version:

1. Before starting, download the latest version of the firmware to your PC (see the note above).
2. An executable (.exe) file is downloaded to the PC. Run this program to place the firmware on the PC for future use. Make a note of the folder where the firmware file was saved.

ATTENTION:

- The extension of the firmware file must be .eff. Opening a file with an incorrect extension may cause the device to stop functioning.
- L'extension du fichier firmware doit être .eff. Si un fichier est ouvert avec une mauvaise extension, l'appareil peut arrêter de fonctionner.

3. On the **Firmware** panel, click **Select File** (see [figure 69](#), **2**). This opens an Explorer window on your PC.
4. Browse to the location of the firmware and select the file (see [figure 70](#)).

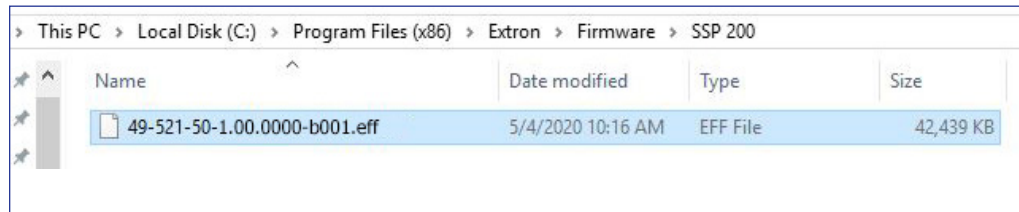

Figure 70. Selecting the Firmware File

5. Click **Open**. The window closes and the **Firmware** panel opens showing the firmware file in the file name field (see figure 71, **1**).

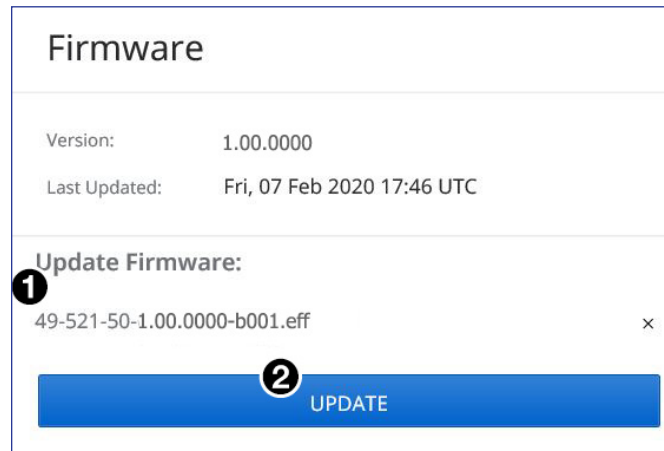

Figure 71. Firmware Panel - Update

6. Click **UPDATE** (**2**). The firmware is uploaded to the connected device.

NOTE: The original factory-installed firmware is permanently available on the SSP 200. If the attempted firmware upload fails for any reason, the processor reverts to the factory version.

Extron Warranty

Extron warrants this product against defects in materials and workmanship for a period of three years from the date of purchase. In the event of malfunction during the warranty period attributable directly to faulty workmanship and/or materials, Extron will, at its option, repair or replace said products or components, to whatever extent it shall deem necessary to restore said product to proper operating condition, provided that it is returned within the warranty period, with proof of purchase and description of malfunction to:

USA, Canada, South America, and Central America:

Extron
1230 South Lewis Street
Anaheim, CA 92805
U.S.A.

Asia:

Extron Asia Pte Ltd
135 Joo Seng Road, #04-01
PM Industrial Bldg.
Singapore 368363
Singapore

Japan:

Extron Japan
Kyodo Building, 16 Ichibancho
Chiyoda-ku, Tokyo 102-0082
Japan

Europe:

Extron Europe
Hanzeboulevard 10
3825 PH Amersfoort
The Netherlands

China:

Extron China
686 Ronghua Road
Songjiang District
Shanghai 201611
China

Middle East:

Extron Middle East
Dubai Airport Free Zone
F13, PO Box 293666
United Arab Emirates, Dubai

Africa:

Extron South Africa
3rd Floor, South Tower
160 Jan Smuts Avenue
Rosebank 2196, South Africa

This Limited Warranty does not apply if the fault has been caused by misuse, improper handling care, electrical or mechanical abuse, abnormal operating conditions, or if modifications were made to the product that were not authorized by Extron.

NOTE: If a product is defective, please call Extron and ask for an Application Engineer to receive an RA (Return Authorization) number. This will begin the repair process.

USA: 714.491.1500 or 800.633.9876

Asia: 65.6383.4400

Europe: 31.33.453.4040 or 800.3987.6673

Japan: 81.3.3511.7655

Africa: 27.11.447.6162

Middle East: 971.4.299.1800

Units must be returned insured, with shipping charges prepaid. If not insured, you assume the risk of loss or damage during shipment. Returned units must include the serial number and a description of the problem, as well as the name of the person to contact in case there are any questions.

Extron makes no further warranties either expressed or implied with respect to the product and its quality, performance, merchantability, or fitness for any particular use. In no event will Extron be liable for direct, indirect, or consequential damages resulting from any defect in this product even if Extron has been advised of such damage.

Please note that laws vary from state to state and country to country, and that some provisions of this warranty may not apply to you.